

QST30-G4

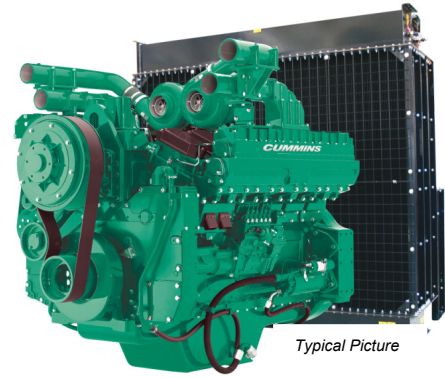

Typical Picture

> Specification sheet

Our energy working for you.™



Description

The QST30 Quantum series utilizes sophisticated electronics and premium engineering to provide outstanding performance levels from its compact 30 liter, V12 configuration.

In fact, the QST30-Series delivers more power and torque in a smaller package than any other diesel engine on the market.



This engine has been built to comply with CE certification.



This engine has been designed in facilities certified to ISO9001 and manufactured in facilities certified to ISO9001 or ISO9002.

Features

Quantum electronic fuel systems and controls provide superior performance, efficiency and diagnostics. The electronic fuel pumps deliver up to 1100 bar injection pressure and eliminate mechanical linkage adjustments. Electronic control module with PGI (Power Generation Interface) provides full authority electronic control over fuel management, G-drive features, protection and diagnostics.

CTT (Cummins Turbo Technologies) HX82 turbo charging utilises exhaust energy with greater efficiency for improved emissions and fuel consumption.

Cast Iron Pistons – High strength design delivers superior durability.

Coolpac Integrated Design - Products are supplied complete with cooling package and air cleaner kit for a complete power package. Each component has been specifically developed and rigorously tested for G-Drive products, ensuring high performance, durability and reliability.

Service and Support - G-Drive products are backed by an uncompromising level of technical support and after sales service, delivered through a world class service network.

1500 rpm (50 Hz Ratings)

Gross Engine Output			Net Engine Output			Typical Generator Set Output					
Standby	Prime	Base	Standby	Prime	Base	Standby (ESP)		Prime (PRP)		Base (COP)	
kWm/BHP			kWm/BHP			kWe	kVA	kWe	kVA	kWe	kVA
970/1300	880/1180	683/915	943/1264	853/1143	656/879	880	1100	800	1000	683	791

1800 rpm (60 Hz Ratings)

Gross Engine Output			Net Engine Output			Typical Generator Set Output					
Standby	Prime	Base	Standby	Prime	Base	Standby (ESP)		Prime (PRP)		Base (COP)	
kWm/BHP			kWm/BHP			kWe	kVA	kWe	kVA	kWe	kVA
1112/1490	1007/1350	832/1115	1070/1434	965/1294	790/1059	1012	1265	920	1150	752	940

Our energy working for you.™

www.cumminsdrive.com

©2013 | Cummins G-Drive Engines | Specifications Subject to Change Without Notice | Cummins is a registered trademark of Cummins Inc. EMERS-5880a-EN (12/13)



General Engine Data

Type	4 cycle, in line, Turbocharged ,Air Cooled		
Bore mm	140.0		
Stroke mm	165.1		
Displacement Litre	30.5		
Cylinder Block	Cast iron, 50°V 12 cylinder		
Battery Charging Alternator	35A		
Starting Voltage	24V		
Fuel System	Direct injection		
Fuel Filter	Spin on fuel filters with water separator		
Lube Oil Filter Type(s)	Spin on full flow filter		
Lube Oil Capacity (l)	154		
Flywheel Dimensions	SAE 0		

CoolPac Performance Data

Cooling System Design	Air to Air Charge Cooled		
Coolant Ratio	50% ethylene glycol; 50% water		
Total Coolant Capacity (l)	192		
Limiting Ambient Temp. (°C)**	52 (50Hz)	52.3 (60Hz)	
Fan Power (kWm)	27 (50Hz)	42 (60Hz)	
Cooling System Air Flow (m ³ /s)**	12.6 (50Hz)	17.07 (60Hz)	
Air Cleaner Type	"Normal Duty" dry replaceable element with restriction indicator		

** @ 13 mm H₂O

CoolPac Weight & Dimensions

Length mm	Width mm	Height mm	Weight (dry) kg
3008	1429	2275	3662

Fuel Consumption 1500 rpm (50 Hz)

%	kWm	BHP	L/ph	US gal/ph
Standby Power				
100	970	1300	224	59.1
Prime Power				
100	880	1180	202	53.2
75	660	885	151	39.8
50	440	590	102	26.9
25	220	295	54	14.2
Continuous Power				
100	683	915	156	41.1

Cummins G-Drive Engines

Asia Pacific

10 Toh Guan Road
#07-01
TT International Tradepark
Singapore 608838
Phone 65 6417 2388
Fax 65 6417 2399

Europe, CIS, Middle East and Africa

Manston Park Columbus Ave
Manston Ramsgate
Kent CT12 5BF, UK
Phone 44 1843 255000
Fax 44 1843 255902

Latin America

Rua Jati, 310, Cumbica
Guarulhos, SP 07180-900
Brazil
Phone 55 11 2186 4552
Fax 55 11 2186 4729

Mexico

Cummins S. de R.L. de C.V.
Eje 122 No. 200 Zona Industrial
San Luis Potosí, S.L.P. 78090
Mexico
Phone 52 444 870 6700
Fax 52 444 870 6811

North America

1400 73rd Avenue N.E.
Minneapolis, MN 55432
USA
Phone 1 763 574 5000
USA Toll-free 1 877 769 7669
Fax 1 763 574 5298

Ratings Definitions

Emergency Standby Power (ESP):

Applicable for supplying power to varying electrical load for the duration of power interruption of a reliable utility source. Emergency Standby Power (ESP) is in accordance with ISO 8528. Fuel Stop power in accordance with ISO 3046, AS 2789, DIN 6271 and BS 5514.

Limited-Time Running Power (LTP):

Applicable for supplying power to a constant electrical load for limited hours. Limited-Time Running Power (LTP) is in accordance with ISO 8528.

Prime Power (PRP):

Applicable for supplying power to varying electrical load for unlimited hours. Prime Power (PRP) is in accordance with ISO 8528. Ten percent overload capability is available in accordance with ISO 3046, AS 2789, DIN 6271 and BS 5514.

Base Load (Continuous) Power (COP):

Applicable for supplying power continuously to a constant electrical load for unlimited hours. Continuous Power (COP) in accordance with ISO 8528, ISO 3046, AS 2789, DIN6271 and BS 5514.

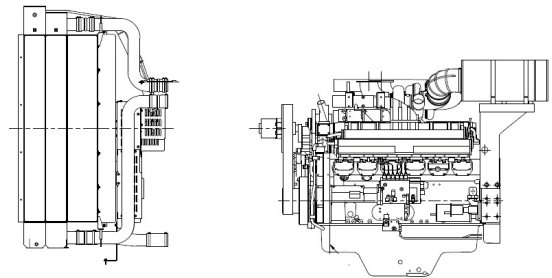

Fuel Consumption 1800 rpm (60 Hz)

%	kWm	BHP	L/ph	US gal/ph
Standby Power				
100	1112	1490	267	70.5
Prime Power				
100	1007	1350	240	63.3
75	756	1013	177	46.7
50	504	675	119	31.5
25	252	338	66	17.4
Continuous Power				
100	832	1115	194	51.4

Our energy working for you.™

www.cumminsgdrive.com

©2013 | Cummins G-Drive Engines | Specifications Subject to Change Without Notice | Cummins is a registered trademark of Cummins Inc.
EMERS-5880a-EN (12/13)



HCI634J - Technical Data Sheet

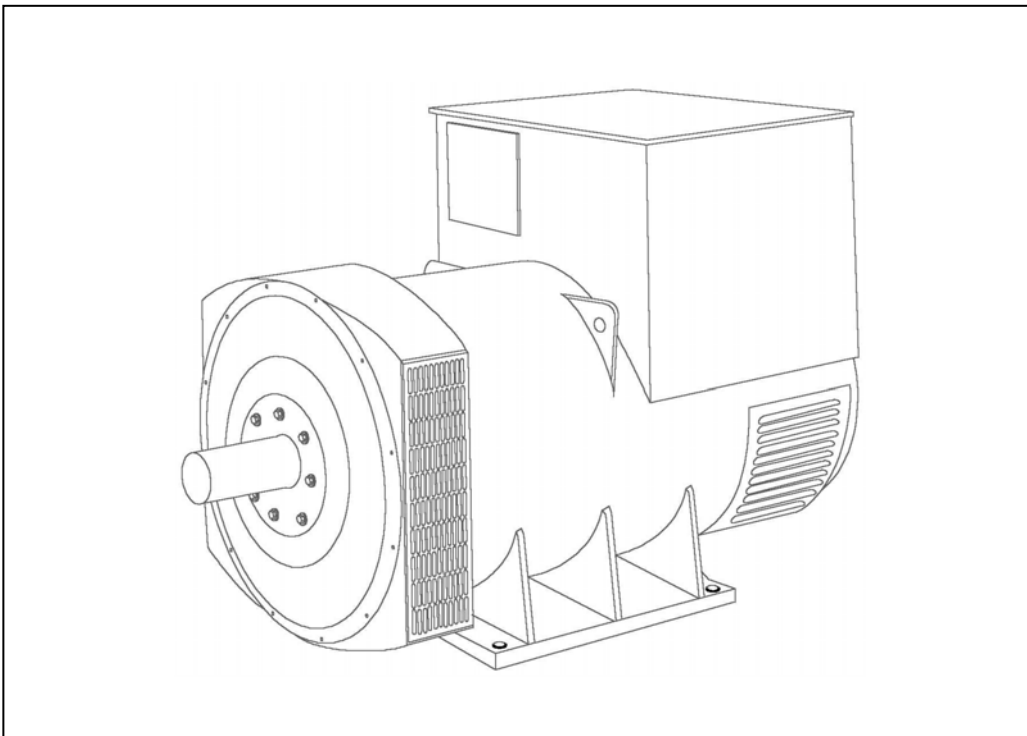

HCI634J

SPECIFICATIONS & OPTIONS



STANDARDS

Newage Stamford industrial generators meet the requirements of BS EN 60034 and the relevant section of other international standards such as BS5000, VDE 0530, NEMA MG1-32, IEC34, CSA C22.2-100, AS1359. Other standards and certifications can be considered on request.

VOLTAGE REGULATORS

MX321 AVR - STANDARD

This sophisticated Automatic Voltage Regulator (AVR) is incorporated into the Stamford Permanent Magnet Generator (PMG) system and is fitted as standard to generators of this type.

The PMG provides power via the AVR to the main exciter, giving a source of constant excitation power independent of generator output. The main exciter output is then fed to the main rotor, through a full wave bridge, protected by a surge suppressor. The AVR has in-built protection against sustained over-excitation, caused by internal or external faults. This de-excites the machine after a minimum of 5 seconds.

Over voltage protection is built-in and short circuit current level adjustments is an optional facility.

WINDINGS & ELECTRICAL PERFORMANCE

All generator stators are wound to 2/3 pitch. This eliminates triplen (3rd, 9th, 15th ...) harmonics on the voltage waveform and is found to be the optimum design for trouble-free supply of non-linear loads. The 2/3 pitch design avoids excessive neutral currents sometimes seen with higher winding pitches, when in parallel with the mains. A fully connected damper winding reduces oscillations during paralleling. This winding, with the 2/3 pitch and carefully selected pole and tooth designs, ensures very low waveform distortion.

TERMINALS & TERMINAL BOX

Standard generators feature a main stator with 6 ends brought out to the terminals, which are mounted on the frame at the non-drive end of the generator. A sheet steel terminal box contains the AVR and provides ample space for the customers' wiring and gland arrangements. It has removable panels for easy access.

SHAFT & KEYS

All generator rotors are dynamically balanced to better than BS6861:Part 1 Grade 2.5 for minimum vibration in operation. Two bearing generators are balanced with a half key.

INSULATION/IMPREGNATION

The insulation system is class 'H'.

All wound components are impregnated with materials and processes designed specifically to provide the high build required for static windings and the high mechanical strength required for rotating components.

QUALITY ASSURANCE

Generators are manufactured using production procedures having a quality assurance level to BS EN ISO 9001.

The stated voltage regulation may not be maintained in the presence of certain radio transmitted signals. Any change in performance will fall within the limits of Criteria 'B' of EN 61000-6-2:2001. At no time will the steady-state voltage regulation exceed 2%.

NB Continuous development of our products entitles us to change specification details without notice, therefore they must not be regarded as binding.

Front cover drawing typical of product range.

HCI634J
WINDING 312

CONTROL SYSTEM	SEPARATELY EXCITED BY P.M.G.		
A.V.R.	MX321		
VOLTAGE REGULATION	± 0.5 %	With 4% ENGINE GOVERNING	
SUSTAINED SHORT CIRCUIT	REFER TO SHORT CIRCUIT DECREMENT CURVES (page 7)		

INSULATION SYSTEM	CLASS H							
PROTECTION	IP23							
RATED POWER FACTOR	0.8							
STATOR WINDING	DOUBLE LAYER LAP							
WINDING PITCH	TWO THIRDS							
WINDING LEADS	6							
STATOR WDG. RESISTANCE	0.002 Ohms PER PHASE AT 22°C STAR CONNECTED							
ROTOR WDG. RESISTANCE	2.09 Ohms at 22°C							
R.F.I. SUPPRESSION	BS EN 61000-6-2 & BS EN 61000-6-4, VDE 0875G, VDE 0875N. refer to factory for others							
WAVEFORM DISTORTION	NO LOAD < 1.5% NON-DISTORTING BALANCED LINEAR LOAD < 5.0%							
MAXIMUM OVERSPEED	2250 Rev/Min							
BEARING DRIVE END	BALL. 6224 (ISO)							
BEARING NON-DRIVE END	BALL. 6317 (ISO)							
	1 BEARING				2 BEARING			
WEIGHT COMP. GENERATOR	2279 kg				2300 kg			
WEIGHT WOUND STATOR	1120 kg				1120 kg			
WEIGHT WOUND ROTOR	962 kg				916 kg			
WR ² INERTIA	22.9287 kgm ²				22.3814 kgm ²			
SHIPPING WEIGHTS in a crate	2328kg				2329kg			
PACKING CRATE SIZE	183 x 92 x 140(cm)				183 x 92 x 140(cm)			
	50 Hz				60 Hz			
TELEPHONE INTERFERENCE	THF<2%				TIF<50			
COOLING AIR	1.614 m ³ /sec 3420 cfm				1.961 m ³ /sec 4156 cfm			
VOLTAGE STAR	380/220	400/231	415/240	440/254	416/240	440/254	460/266	480/277
VOLTAGE DELTA	220	230	240	254	240	254	266	277
kVA BASE RATING FOR REACTANCE VALUES	1000	1000	1000	1000	1150	1200	1250	1300
X _d DIR. AXIS SYNCHRONOUS	3.02	2.73	2.54	2.26	3.49	3.25	3.10	2.96
X' _d DIR. AXIS TRANSIENT	0.24	0.22	0.20	0.18	0.28	0.26	0.25	0.24
X'' _d DIR. AXIS SUBTRANSIENT	0.17	0.15	0.14	0.12	0.19	0.18	0.17	0.16
X _q QUAD. AXIS REACTANCE	1.78	1.61	1.50	1.33	2.05	1.91	1.82	1.74
X'' _q QUAD. AXIS SUBTRANSIENT	0.21	0.19	0.18	0.16	0.25	0.23	0.22	0.21
X _L LEAKAGE REACTANCE	0.09	0.08	0.08	0.07	0.10	0.10	0.09	0.09
X ₂ NEGATIVE SEQUENCE	0.21	0.19	0.18	0.16	0.25	0.23	0.22	0.21
X ₀ ZERO SEQUENCE	0.03	0.02	0.02	0.02	0.03	0.03	0.03	0.03
REACTANCES ARE SATURATED VALUES ARE PER UNIT AT RATING AND VOLTAGE INDICATED								
T' _d TRANSIENT TIME CONST.	0.185							
T'' _d SUB-TRANSTIME CONST.	0.025							
T' _{do} O.C. FIELD TIME CONST.	3.03							
T _a ARMATURE TIME CONST.	0.046							
SHORT CIRCUIT RATIO	1/X _d							

**50
Hz**

HCI634J
Winding 312



THREE PHASE EFFICIENCY CURVES

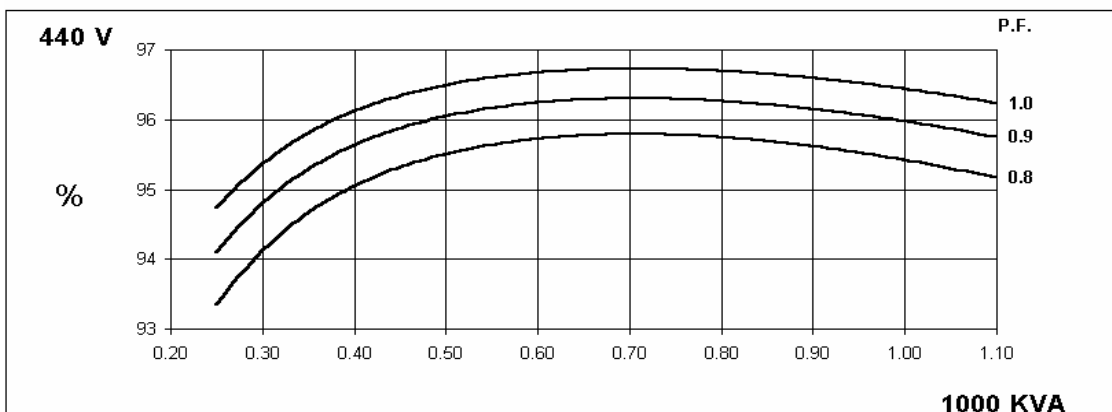
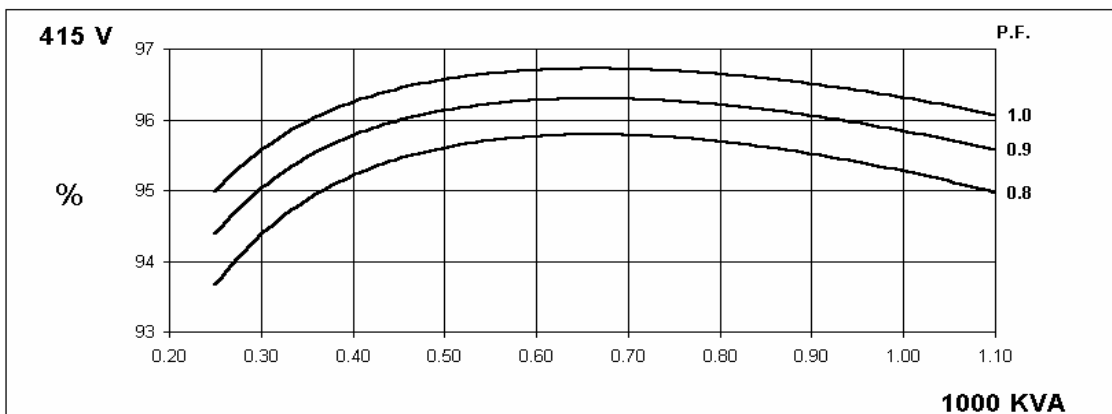
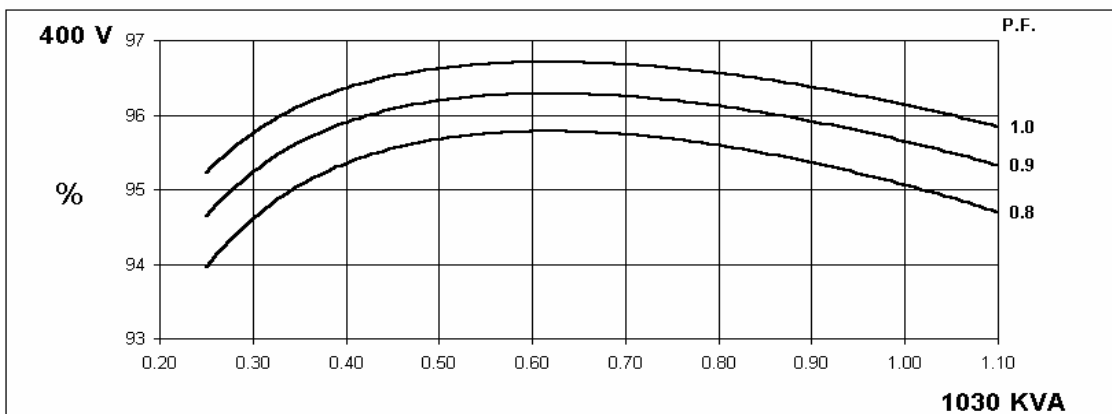
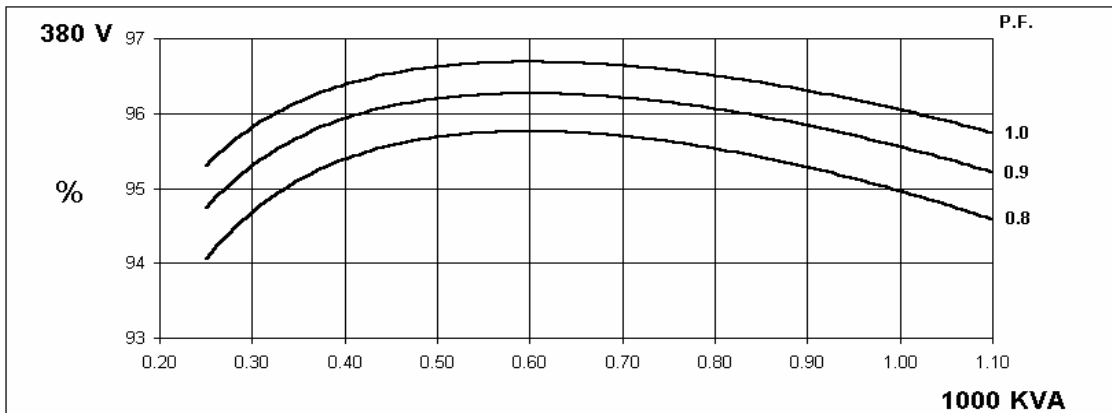

THREE PHASE EFFICIENCY CURVES

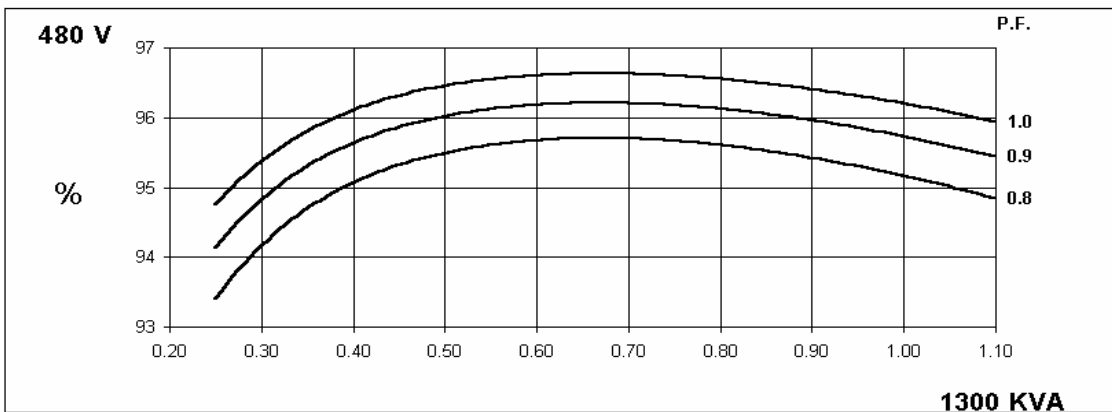
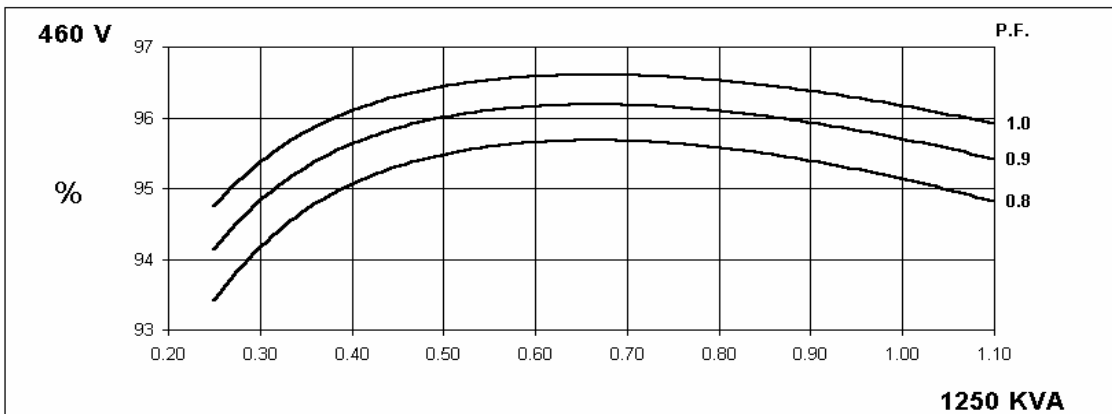
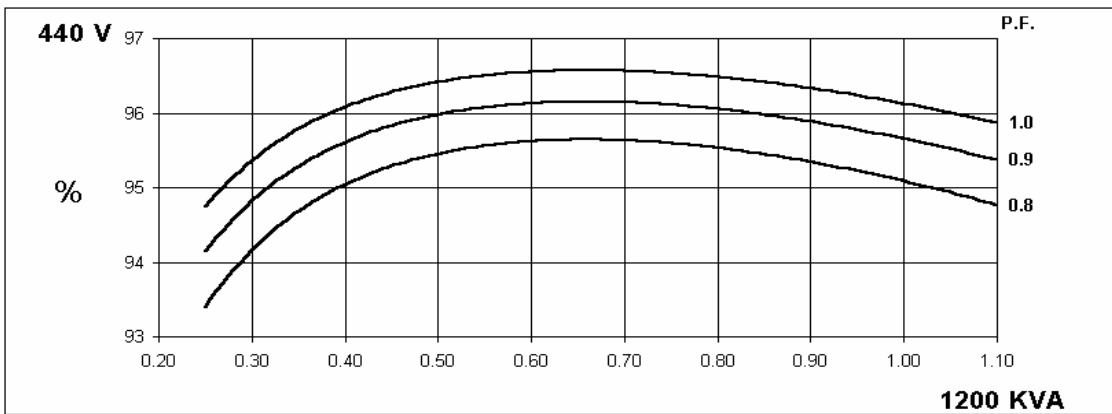
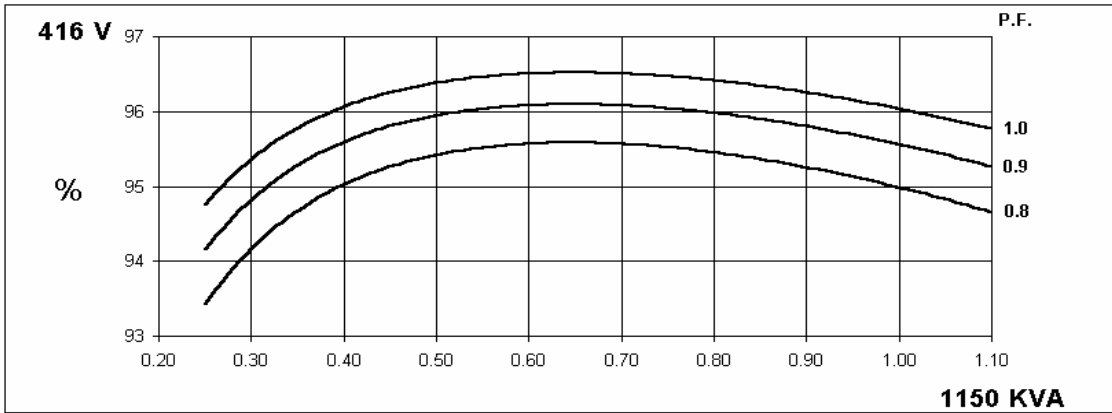

HCI634J

Winding 312



Locked Rotor Motor Starting Curve

**50
Hz**

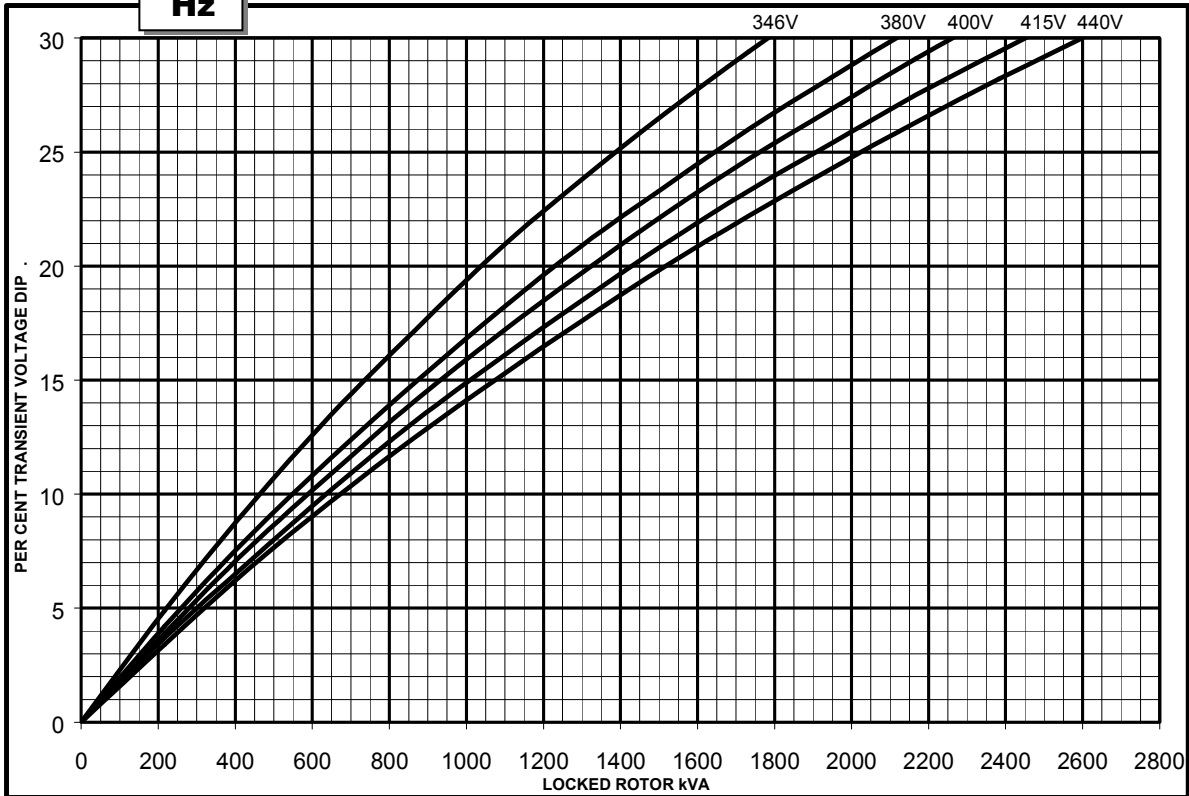

**60
Hz**

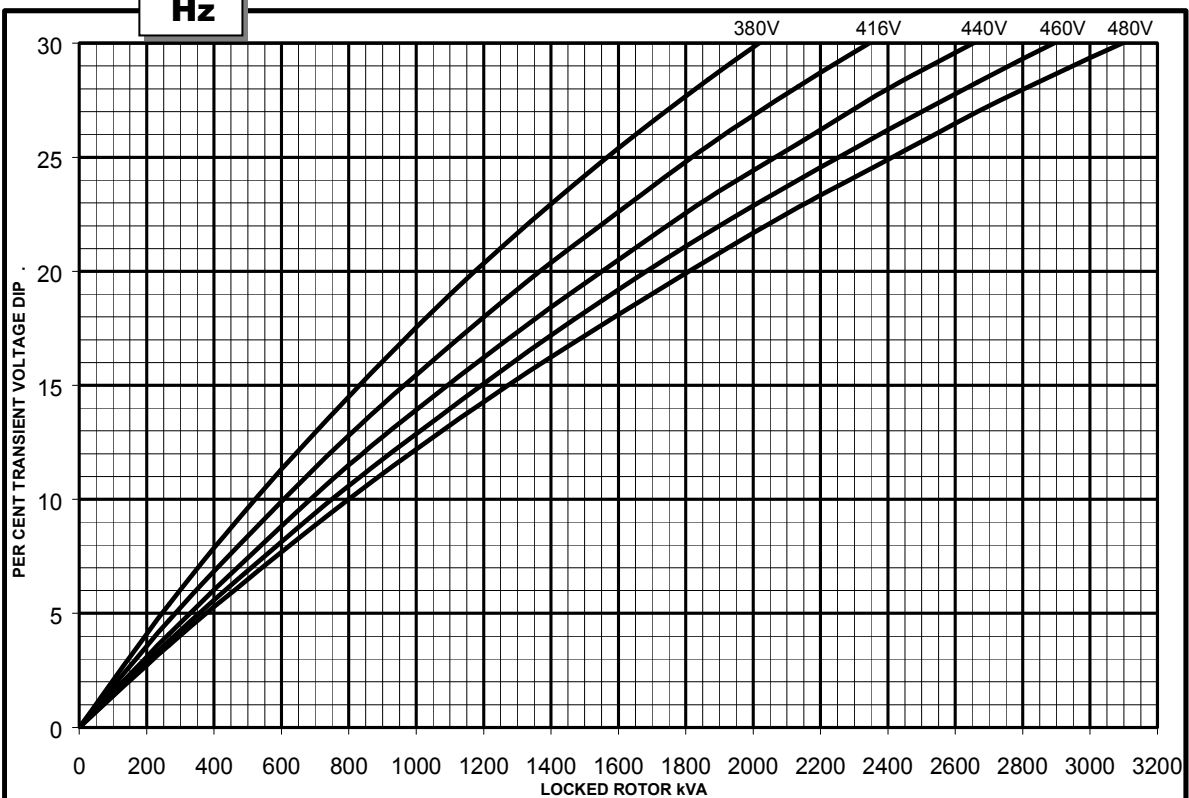

**Three-phase Short Circuit Decrement Curve. No-load Excitation at Rated Speed
Based on star (wye) connection.**

**50
Hz**

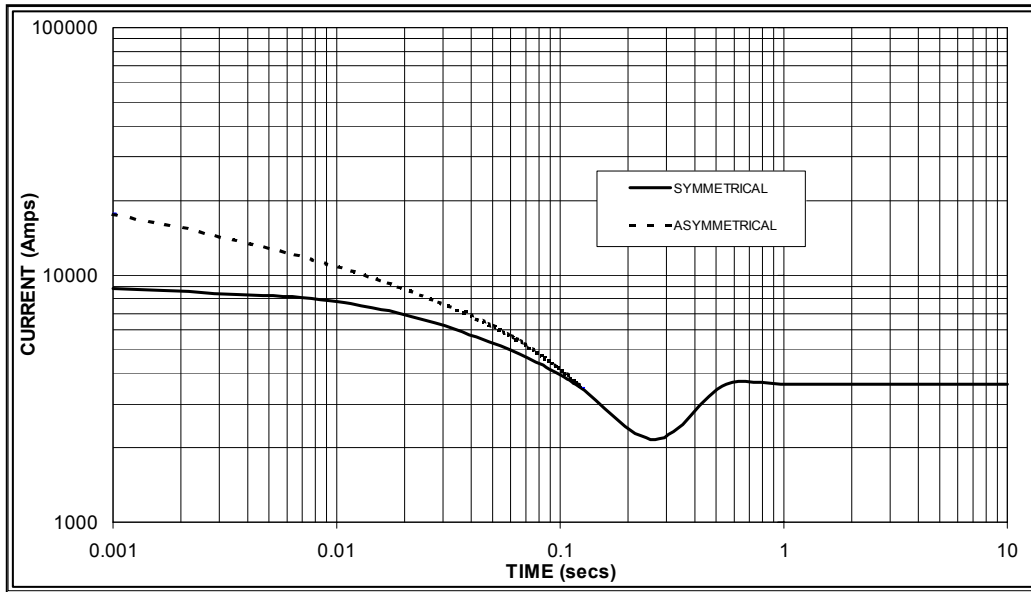

Sustained Short Circuit = 3,600 Amps

**60
Hz**

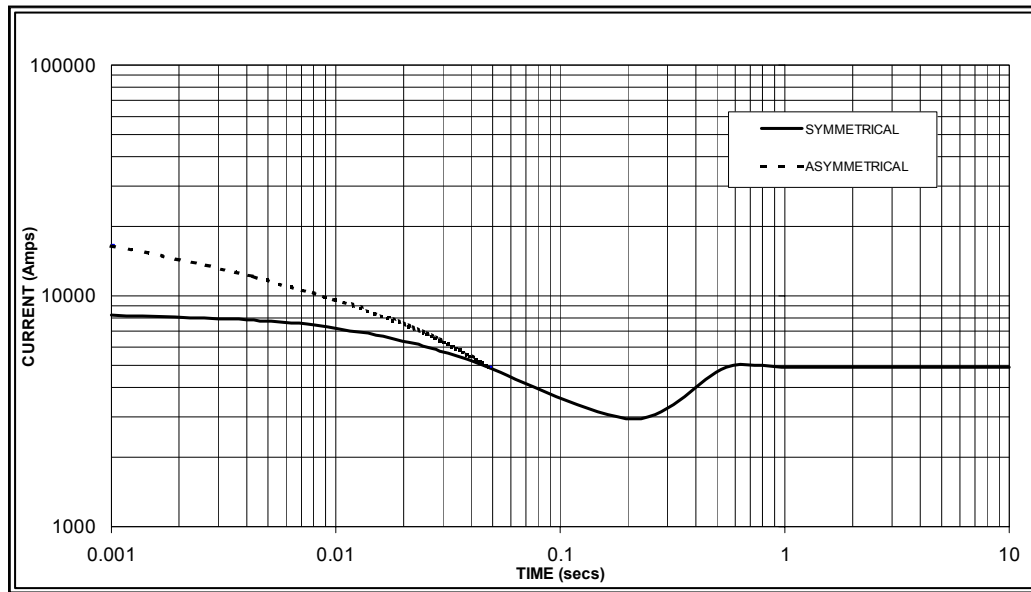

Sustained Short Circuit = 4,900 Amps

Note 1

The following multiplication factors should be used to adjust the values from curve between time 0.001 seconds and the minimum current point in respect of nominal operating voltage :

50Hz		60Hz	
Voltage	Factor	Voltage	Factor
380v	X 1.00	416v	x 1.00
400v	X 1.07	440v	x 1.06
415v	X 1.12	460v	x 1.12
440v	X 1.18	480v	x 1.17

The sustained current value is constant irrespective of voltage level

Note 2

The following multiplication factor should be used to convert the values calculated in accordance with NOTE 1 to those applicable to the various types of short circuit :

	3-phase	2-phase L-L	1-phase L-N
Instantaneous	x 1.00	x 0.87	x 1.30
Minimum	x 1.00	x 1.80	x 3.20
Sustained	x 1.00	x 1.50	x 2.50
Max. sustained duration	10 sec.	5 sec.	2 sec.

All other times are unchanged

Note 3

Curves are drawn for Star (Wye) connected machines.
For Delta connection multiply the Curve current value by 1.732

HCI634J

Winding 312 0.8 Power Factor



RATINGS

Class - Temp Rise		Cont. F - 105/40°C				Cont. H - 125/40°C				Standby - 150/40°C				Standby - 163/27°C			
50Hz	Star (V)	380	400	415	440	380	400	415	440	380	400	415	440	380	400	415	440
	Delta (V)	220	230	240	254	220	230	240	254	220	230	240	254	220	230	240	254
	kVA	900	927	900	900	1000	1030	1000	1000	1060	1070	1060	1060	1100	1110	1100	1100
	kW	720	742	720	720	800	824	800	800	848	856	848	848	880	888	880	880
	Efficiency (%)	95.3	95.4	95.5	95.6	95.0	95.1	95.3	95.4	94.7	94.9	95.1	95.3	94.6	94.8	95.0	95.2
	kW Input	756	777	754	753	842	866	839	839	895	902	892	890	930	937	926	924
60Hz	Star (V)	416	440	460	480	416	440	460	480	416	440	460	480	416	440	460	480
	Delta (V)	240	254	266	277	240	254	266	277	240	254	266	277	240	254	266	277
	kVA	1063	1100	1150	1188	1150	1200	1250	1300	1206	1250	1300	1350	1250	1300	1350	1400
	kW	850	880	920	950	920	960	1000	1040	965	1000	1040	1080	1000	1040	1080	1120
	Efficiency (%)	95.2	95.3	95.3	95.4	95.0	95.1	95.1	95.2	94.8	95.0	95.0	95.1	94.7	94.8	94.9	94.9
	kW Input	893	923	965	996	968	1009	1052	1092	1018	1053	1095	1136	1056	1097	1138	1180

DIMENSIONS

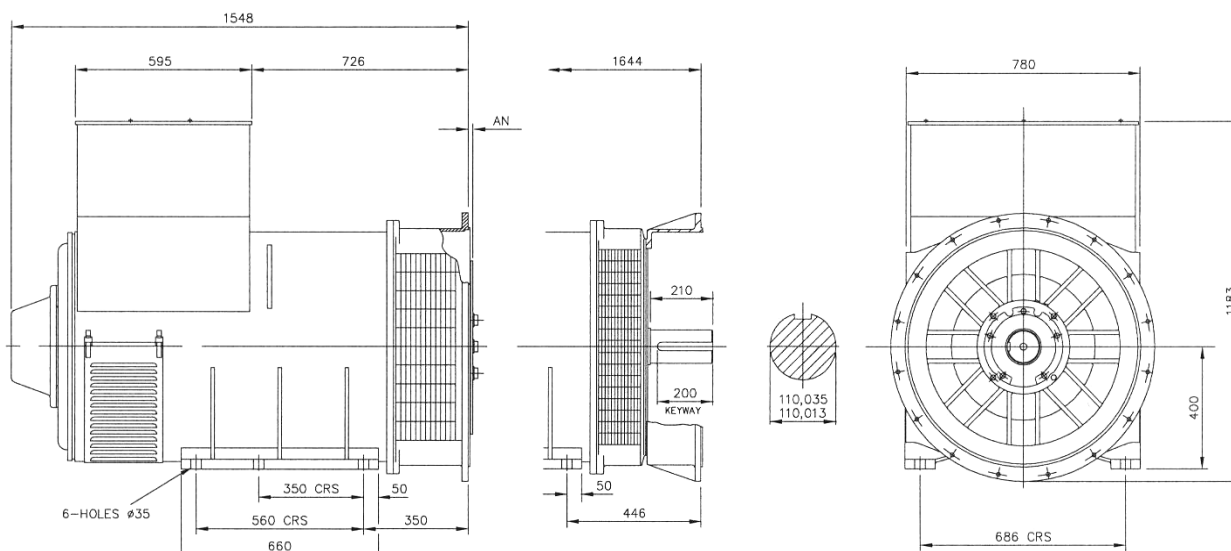

SAE	14	18	21	24
AN	25.4	15.87	0	0



PO Box 17 • Barnack Road • Stamford • Lincolnshire • PE9 2NB

Tel: 00 44 (0)1780 484000 • Fax: 00 44 (0)1780 484100

Website: www.newage-avkseg.com