

STAMFORD®

PI042G - Winding 311

Technical Data Sheet

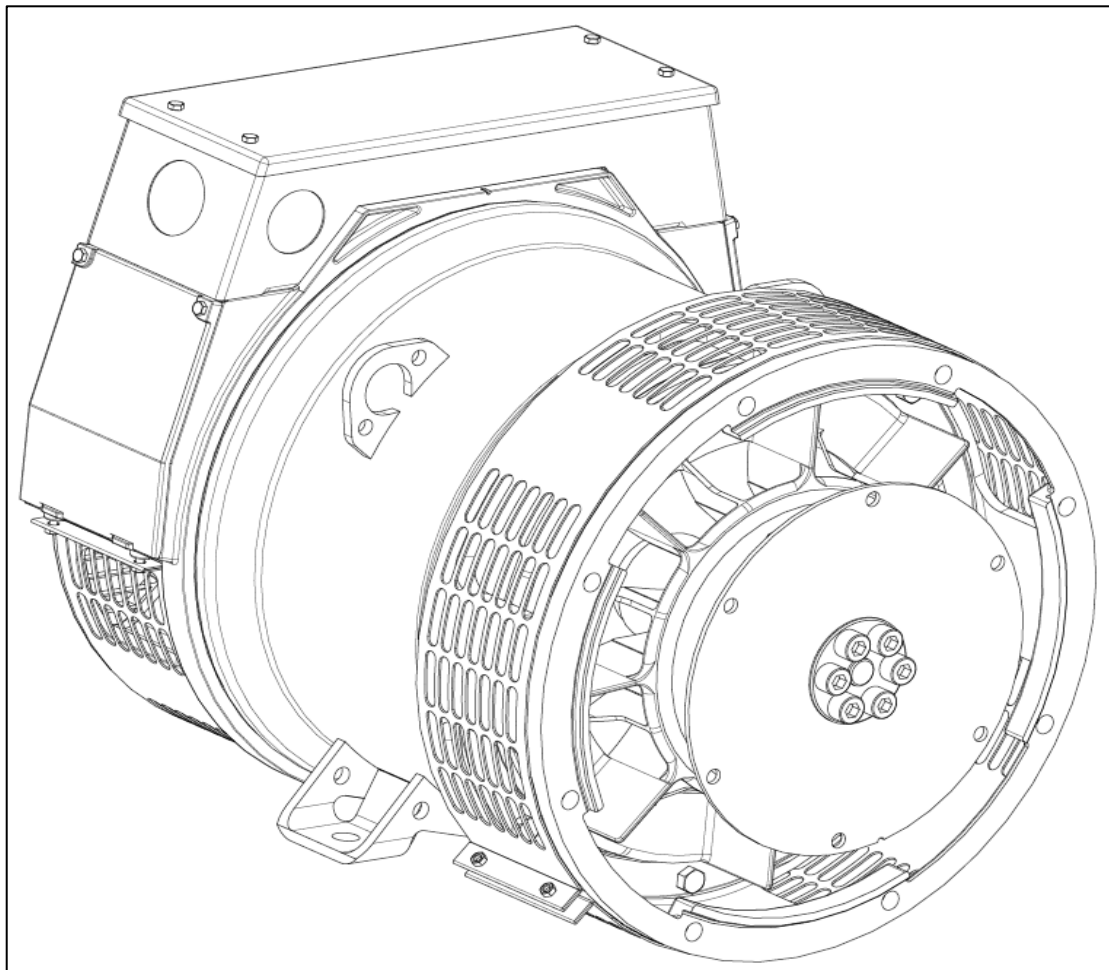

PI042G

SPECIFICATIONS & OPTIONS

STANDARDS

Stamford industrial generators meet the requirements of BS EN 60034 and the relevant section of other international standards such as BS5000, VDE 0530, NEMA MG1-32, IEC34, CSA C22.2-100, AS1359. Other standards and certifications can be considered on request.

VOLTAGE REGULATOR

AS480 AVR fitted as STANDARD

With this self-excited system the main stator provides power via the AVR to the exciter stator. The high efficiency semi-conductors of the AVR ensure positive build-up from initial low levels of residual voltage.

The exciter rotor output is fed to the main rotor through a three-phase full-wave bridge rectifier. The rectifier is protected by a surge suppressor against surges caused, for example, by short circuit or out-of-phase paralleling. The AS480 will support limited accessories, RFI suppression remote voltage trimmer and for the P1 range only a 'droop' Current Transformer (CT) to permit parallel operation with other ac generators.

The AVR is can be fitted to either side of the generator in its own housing in the non-drive end bracket.

Excitation Boost System (EBS) (OPTIONAL)

The EBS is a single, self-contained unit, attached to the non-drive end of the generator.

The EBS unit consists of the Excitation Boost Controller (EBC) and an Excitation Boost Generator (EBG). Under fault conditions, or when the generator is subjected to a large impact load such as a motor starting, the generator voltage will drop. The EBC senses the drop in voltage and engages the output power of the EBG. This additional power feeds the generator's excitation system, supporting the load until breaker discrimination can remove the fault or enable the generator to pick up a motor and drive the voltage recovery.

WINDINGS & ELECTRICAL PERFORMANCE

All generator stators are wound to 2/3 pitch. This eliminates triplen (3rd, 9th, 15th ...) harmonics on the voltage waveform and is found to be the optimum design for trouble-free supply of non-linear loads. The 2/3 pitch design avoids excessive neutral currents sometimes seen with higher winding pitches, when in parallel with the mains. A fully connected damper winding reduces oscillations during paralleling. This winding, with the 2/3 pitch and carefully selected pole and tooth designs, ensures very low waveform distortion.

TERMINALS & TERMINAL BOX

Standard generators are 3-phase reconnectable with 12 ends brought out to the terminals, which are mounted at the non-drive end of the generator. Dedicated single phase generators are also available. A sheet steel terminal box contains provides ample space for the customers' wiring and gland arrangements. Alternative terminal boxes are available for customers who want to fit additional components in the terminal box.

SHAFT & KEYS

All generator rotors are dynamically balanced to better than BS6861:Part 1 Grade 2.5 for minimum vibration in operation. Two bearing generators are balanced with a half key.

INSULATION / IMPREGNATION

The insulation system is class 'H'.

All wound components are impregnated with materials and processes designed specifically to provide the high build required for static windings and the high mechanical strength required for rotating components.

QUALITY ASSURANCE

Generators are manufactured using production procedures having a quality assurance level to BS EN ISO 9001.

The stated voltage regulation may not be maintained in the presence of certain radio transmitted signals. Any change in performance will fall within the limits of Criteria 'B' of EN 61000-6-2:2001. At no time will the steady-state voltage regulation exceed 2%.

DE RATES

All values tabulated on page 9 are subject to the following reductions

5% when air inlet filters are fitted.

3% for every 500 metres by which the operating altitude exceeds 1000 metres above mean sea level.

3% for every 5°C by which the operational ambient temperature exceeds 40°C.

Note: Requirement for operating in an ambient exceeding 60°C must be referred to the factory.

5% For reverse rotation

(Standard rotation CW when viewed from DE)

NB Continuous development of our products entitles us to change specification details without notice, therefore they must not be regarded as binding.

Front cover drawing typical of product range.

PI042G



WINDING 311

| | | | | | | | | |
|--|--|------------------------|-------------------------|-------------------------|-----------------------------------|-------------------------|-------------------------|-------------------------|
| CONTROL SYSTEM | STANDARD AS480 AVR (SELF EXCITED) | | | | | | | |
| VOLTAGE REGULATION | ± 1.0 % | | | | | | | |
| SUSTAINED SHORT CIRCUIT | SELF EXCITED MACHINES DO NOT SUSTAIN A SHORT CIRCUIT CURRENT | | | | | | | |
| CONTROL SYSTEM | AS480 AVR WITH OPTIONAL EXCITATION BOOST SYSTEM (EBS) | | | | | | | |
| SUSTAINED SHORT CIRCUIT | REFER TO SHORT CIRCUIT DECREMENT CURVE (page 8) | | | | | | | |
| INSULATION SYSTEM | CLASS H | | | | | | | |
| PROTECTION | IP23 | | | | | | | |
| RATED POWER FACTOR | 0.8 | | | | | | | |
| STATOR WINDING | DOUBLE LAYER CONCENTRIC | | | | | | | |
| WINDING PITCH | TWO THIRDS | | | | | | | |
| WINDING LEADS | 12 | | | | | | | |
| STATOR WDG. RESISTANCE | 0.536 Ohms PER PHASE AT 22°C SERIES STAR CONNECTED | | | | | | | |
| ROTOR WDG. RESISTANCE | 0.993 Ohms at 22°C | | | | | | | |
| EXCITER STATOR RESISTANCE | 13.5 Ohms at 22°C | | | | | | | |
| EXCITER ROTOR RESISTANCE | 0.0479 Ohms PER PHASE AT 22°C | | | | | | | |
| EBS STATOR RESISTANCE | 12.9 Ohms at 22°C | | | | | | | |
| R.F.I. SUPPRESSION | BS EN 61000-6-2 & BS EN 61000-6-4, VDE 0875G, VDE 0875N. refer to factory for others | | | | | | | |
| WAVEFORM DISTORTION | NO LOAD < 1.5% NON-DISTORTING BALANCED LINEAR LOAD < 5.0% | | | | | | | |
| MAXIMUM OVERSPEED | 4500 Rev/Min | | | | | | | |
| BEARING DRIVE END | BALL. 6309 - 2RS. (ISO) | | | | | | | |
| BEARING NON-DRIVE END | BALL. 6306 - 2RS. (ISO) | | | | | | | |
| | 1 BEARING | | | | 2 BEARING | | | |
| | WITH EBS | | WITHOUT EBS | | WITH EBS | | WITHOUT EBS | |
| WEIGHT COMP. GENERATOR | 95 kg | 93.3 kg | 98 kg | 96.3 kg | 98 kg | 96.3 kg | 98 kg | 96.3 kg |
| WEIGHT WOUND STATOR | 43 kg | 43 kg | 43 kg | 43 kg | 43 kg | 43 kg | 43 kg | 43 kg |
| WEIGHT WOUND ROTOR | 28.3 kg | 26.6 kg | 29.31 kg | 27.61 kg | 29.31 kg | 27.61 kg | 29.31 kg | 27.61 kg |
| WR ² INERTIA | 0.0767 kgm ² | 0.075 kgm ² | 0.0768 kgm ² | 0.0751 kgm ² | 0.0768 kgm ² | 0.0751 kgm ² | 0.0768 kgm ² | 0.0751 kgm ² |
| SHIPPING WEIGHTS in a crate | 112 kg | 110.3 kg | 121 kg | 119.3 kg | 121 kg | 119.3 kg | 121 kg | 119.3 kg |
| PACKING CRATE SIZE | 71 x 51 x 67 (cm) | | | | 71 x 51 x 67 (cm) | | | |
| | 50 Hz | | | | 60 Hz | | | |
| TELEPHONE INTERFERENCE | THF<2% | | | | TIF<50 | | | |
| COOLING AIR | 0.205 m ³ /sec 434 cfm | | | | 0.241 m ³ /sec 511 cfm | | | |
| VOLTAGE SERIES STAR | 380/220 | 400/231 | 415/240 | 440/254 | 416/240 | 440/254 | 460/266 | 480/277 |
| VOLTAGE PARALLEL STAR | 190/110 | 200/115 | 208/120 | 220/127 | 208/120 | 220/127 | 230/133 | 240/138 |
| VOLTAGE SERIES DELTA | 220/110 | 230/115 | 240/120 | 254/127 | 240/120 | 254/127 | 266/133 | 277/138 |
| kVA BASE RATING FOR REACTANCE VALUES | 20 | 20 | 20 | 19.4 | 22 | 23.3 | 23.3 | 23.3 |
| X _d DIR. AXIS SYNCHRONOUS | 2.12 | 1.91 | 1.77 | 1.53 | 2.51 | 2.38 | 2.17 | 2.00 |
| X' _d DIR. AXIS TRANSIENT | 0.21 | 0.19 | 0.18 | 0.15 | 0.25 | 0.24 | 0.22 | 0.20 |
| X'' _d DIR. AXIS SUBTRANSIENT | 0.13 | 0.12 | 0.11 | 0.10 | 0.16 | 0.15 | 0.14 | 0.13 |
| X _q QUAD. AXIS REACTANCE | 1.06 | 0.96 | 0.89 | 0.77 | 1.26 | 1.19 | 1.09 | 1.00 |
| X'' _q QUAD. AXIS SUBTRANSIENT | 0.24 | 0.22 | 0.20 | 0.18 | 0.29 | 0.27 | 0.25 | 0.23 |
| X _L LEAKAGE REACTANCE | 0.09 | 0.08 | 0.07 | 0.06 | 0.11 | 0.10 | 0.10 | 0.09 |
| X ₂ NEGATIVE SEQUENCE | 0.20 | 0.18 | 0.17 | 0.14 | 0.24 | 0.23 | 0.21 | 0.19 |
| X ₀ ZERO SEQUENCE | 0.09 | 0.08 | 0.07 | 0.06 | 0.11 | 0.10 | 0.10 | 0.09 |
| REACTANCES ARE SATURATED VALUES ARE PER UNIT AT RATING AND VOLTAGE INDICATED | | | | | | | | |
| T' _d TRANSIENT TIME CONST. | 0.01 s | | | | | | | |
| T'' _d SUB-TRANSTIME CONST. | 0.003 s | | | | | | | |
| T' _{do} O.C. FIELD TIME CONST. | 0.19 s | | | | | | | |
| T _a ARMATURE TIME CONST. | 0.004 s | | | | | | | |
| SHORT CIRCUIT RATIO | 1/X _d | | | | | | | |

50
Hz

PI042G
Winding 311

STAMFORD

THREE PHASE EFFICIENCY CURVES

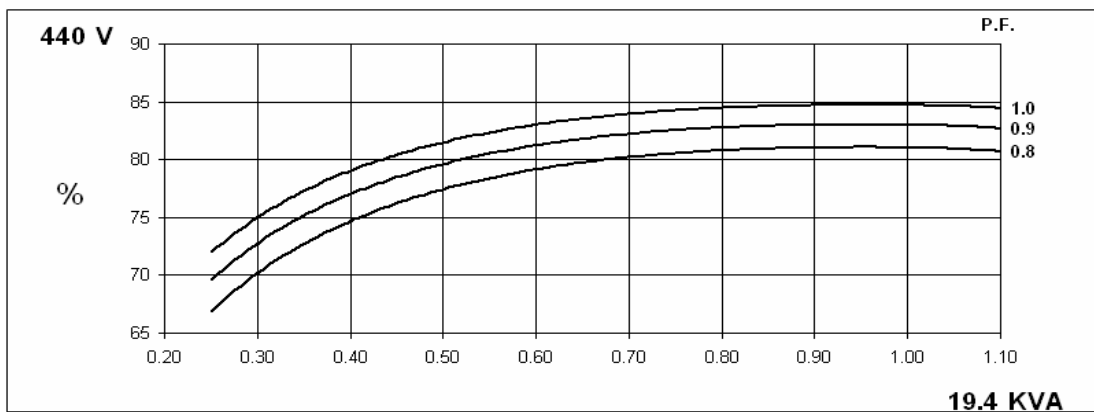
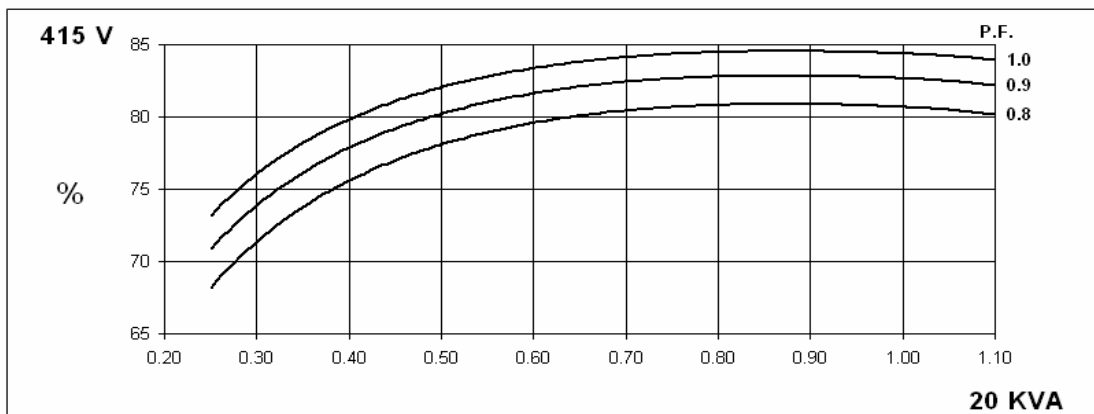
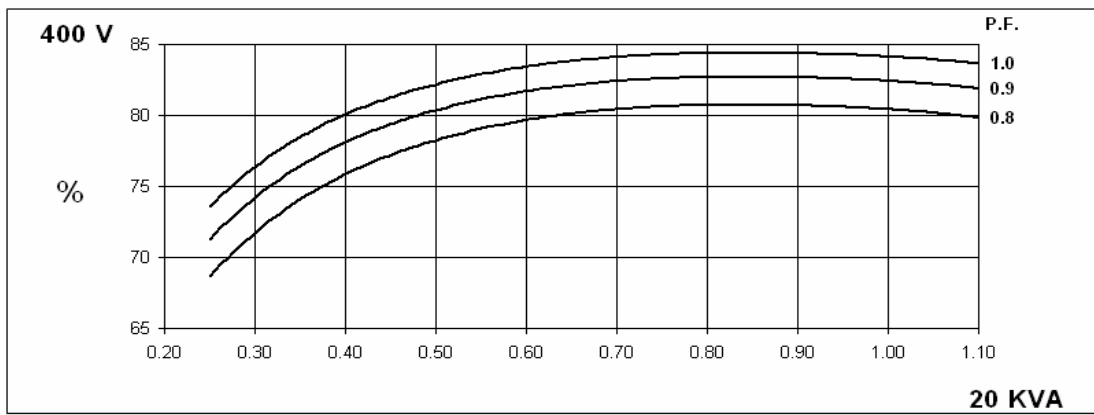
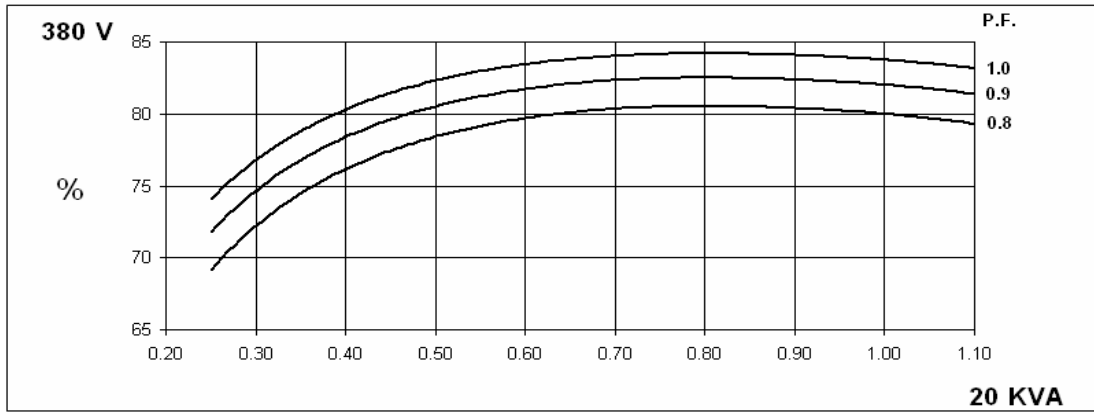

60
Hz

PI042G
Winding 311

STAMFORD

THREE PHASE EFFICIENCY CURVES

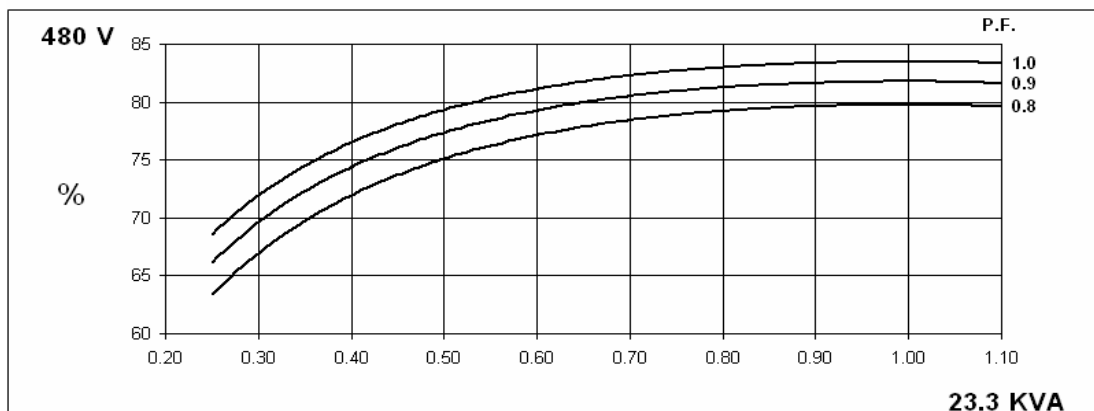
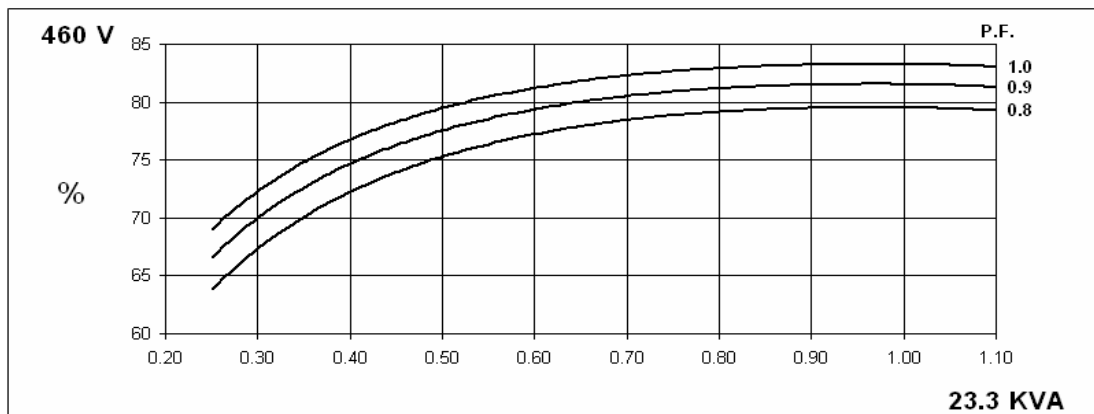
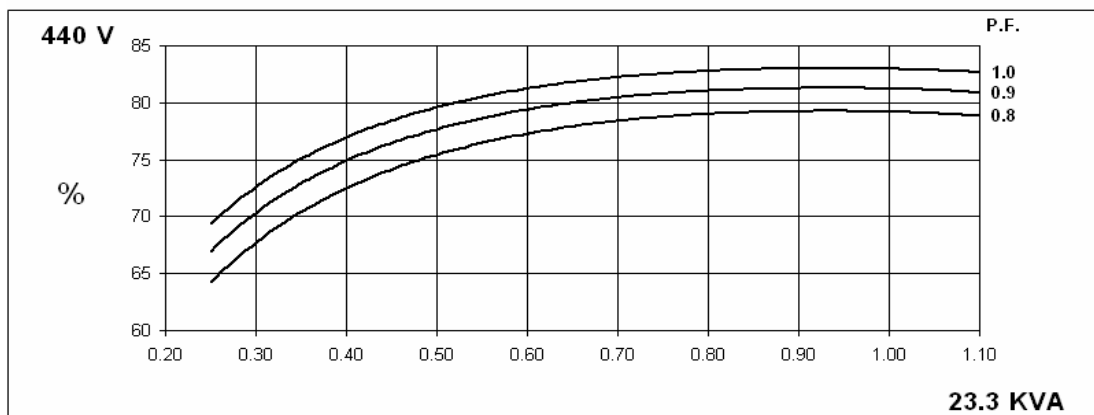
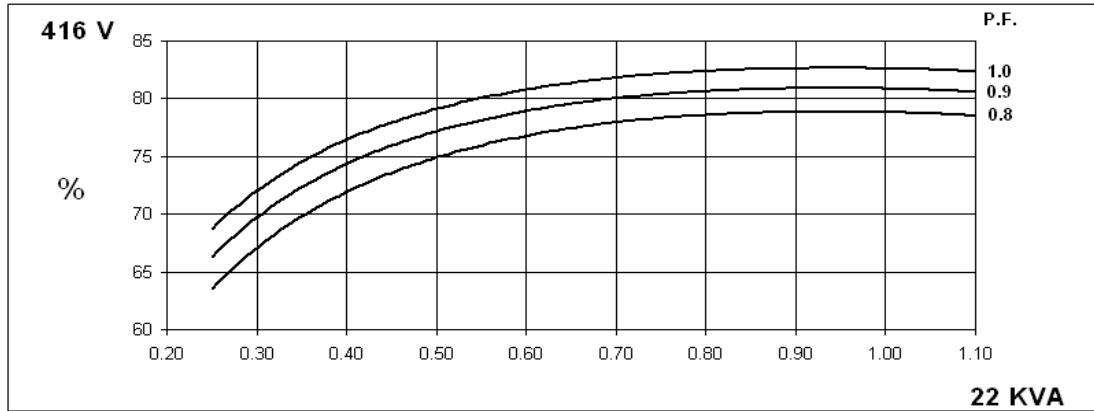

PI042G
Winding 311
AS480 AVR Without EBS
Locked Rotor Motor Starting Curves

50
Hz

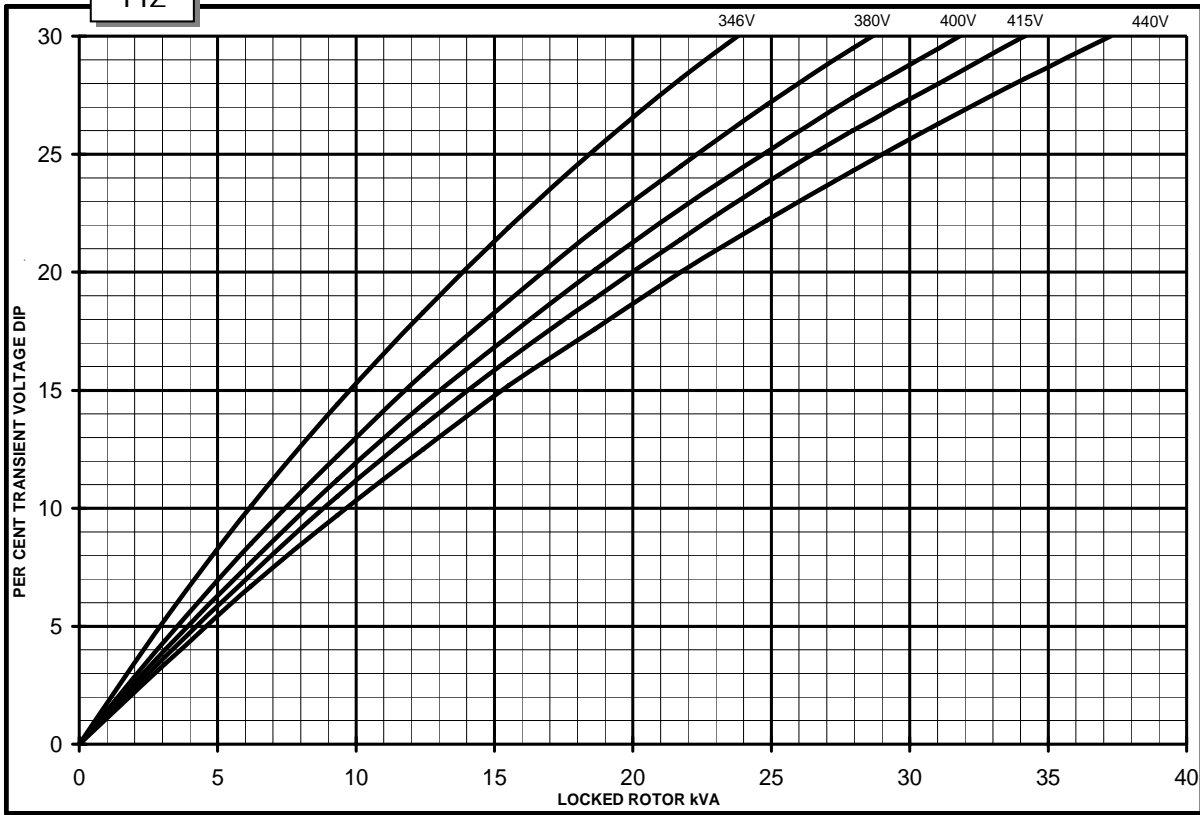

60
Hz

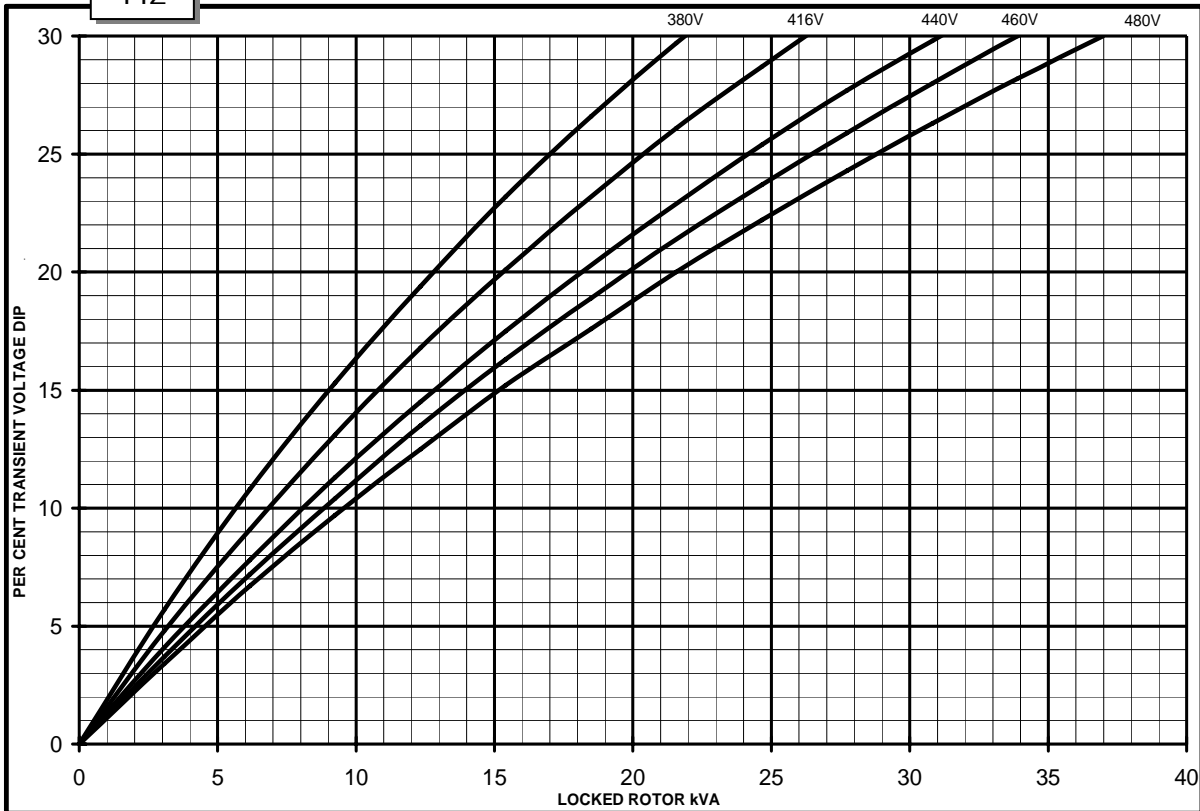

PI042G
Winding 311
AS480 AVR With EBS fitted
Locked Rotor Motor Starting Curves

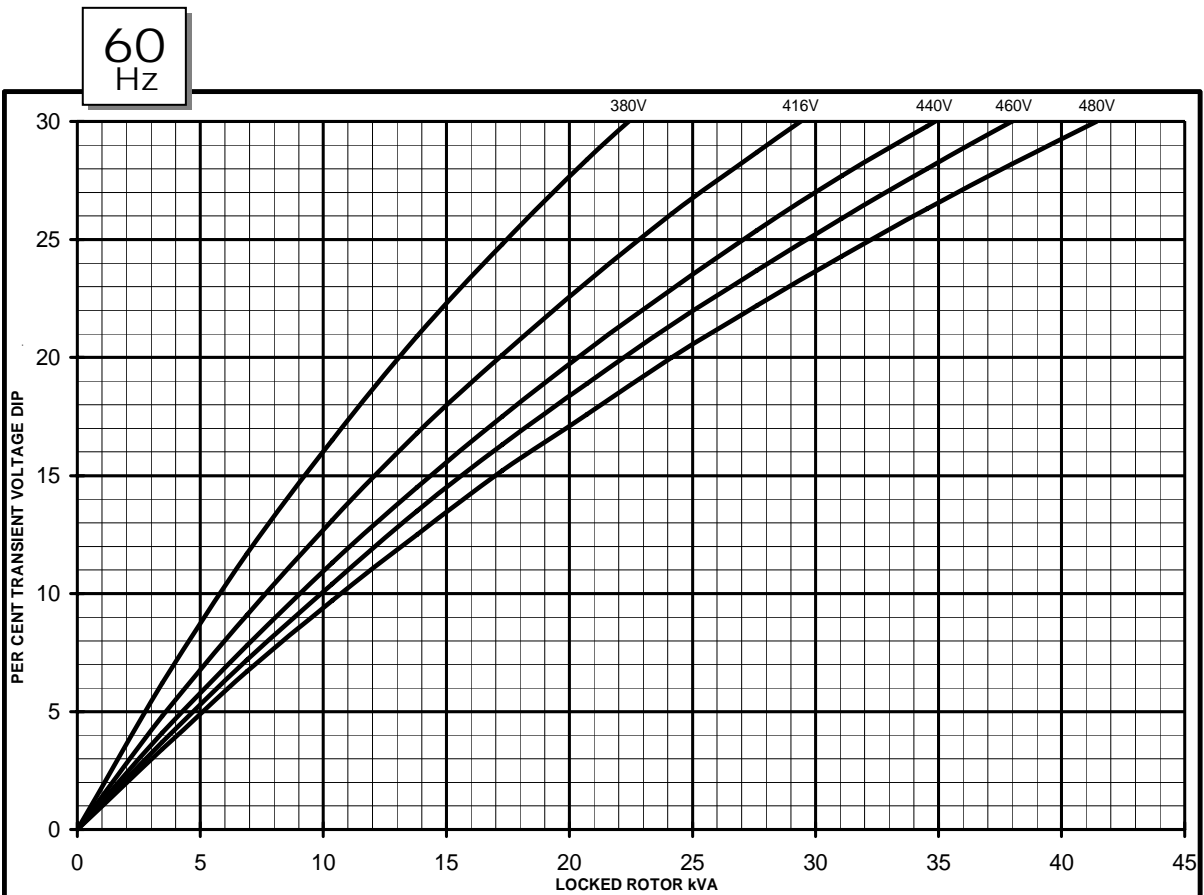
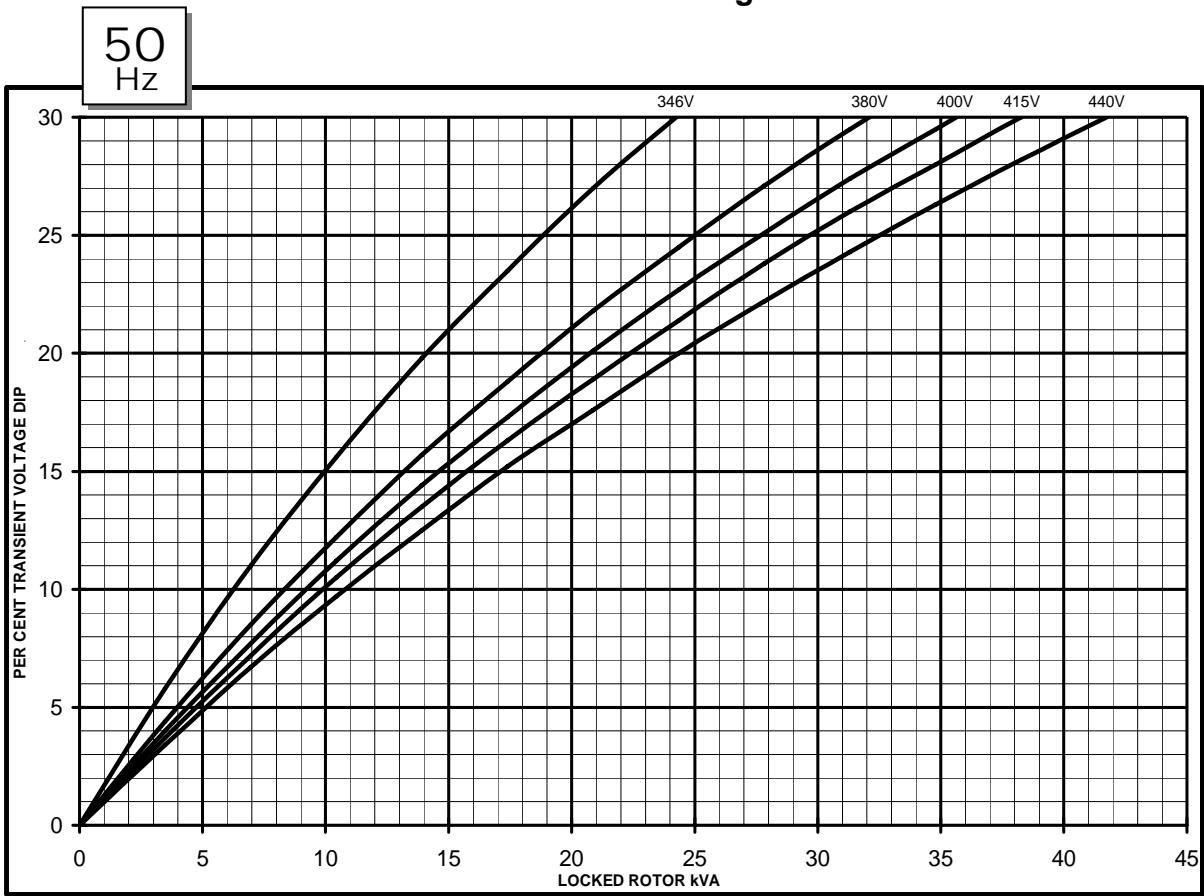

**PI042G
WITH EBS FITTED**

**Three-phase Short Circuit Decrement Curve. No-load Excitation at Rated Speed
Based on star (wye) connection.**

**50
Hz**

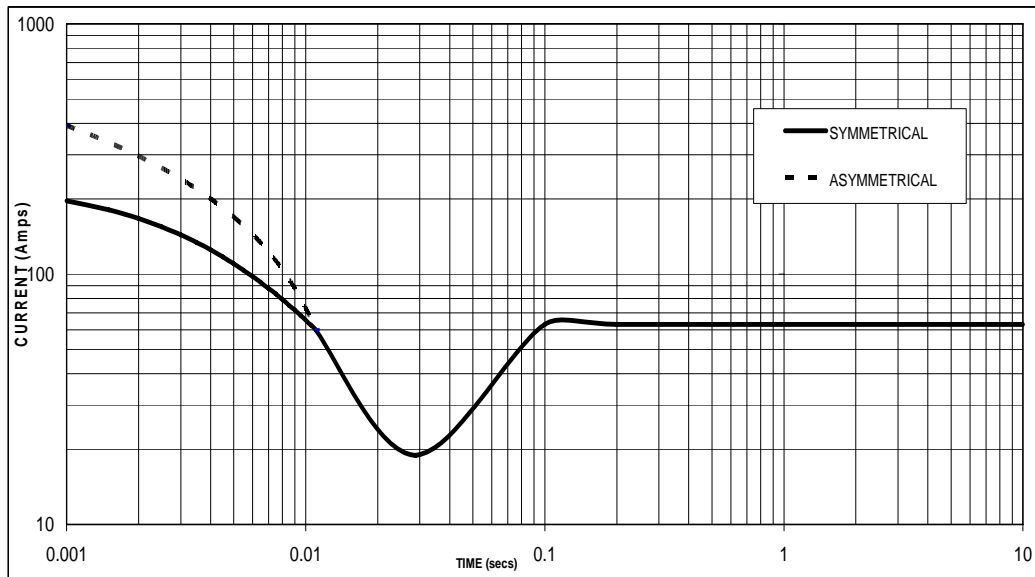

Sustained Short Circuit = 63 Amps

**60
Hz**

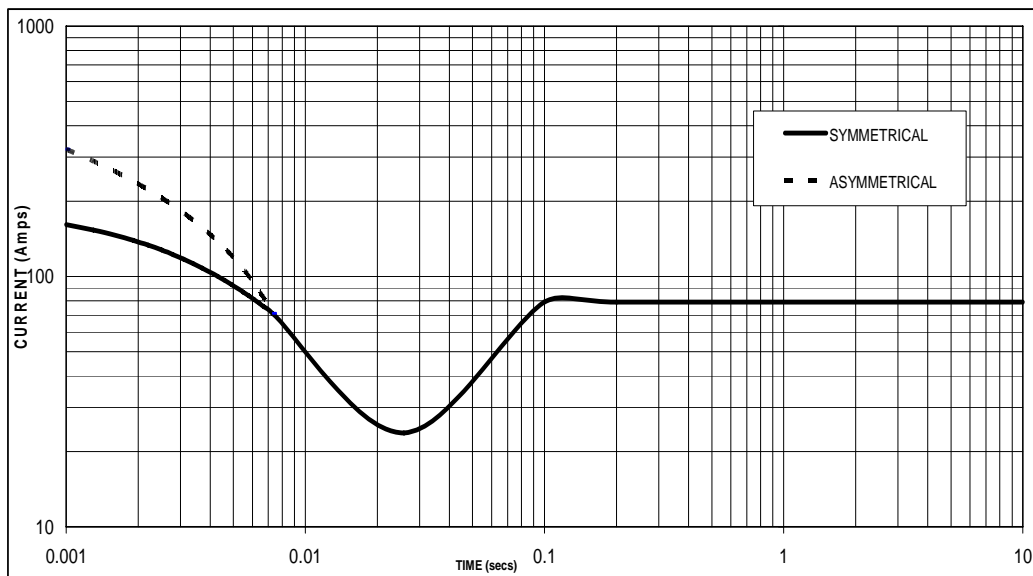

Sustained Short Circuit = 79 Amps

Note 1

The following multiplication factors should be used to adjust the values from curve between time 0.001 seconds and the minimum current point in respect of nominal operating voltage :

| 50Hz | | 60Hz | |
|---------|--------|---------|--------|
| Voltage | Factor | Voltage | Factor |
| 380v | X 1.00 | 416v | X 1.00 |
| 400v | X 1.05 | 440v | X 1.06 |
| 415v | X 1.09 | 460v | X 1.10 |
| 440v | X 1.16 | 480v | X 1.15 |

The sustained current value is constant irrespective of voltage level

Note 2

The following multiplication factor should be used to convert the values calculated in accordance with NOTE 1 to those applicable to the various types of short circuit :

| | 3-phase | 2-phase L-L | 1-phase L-N |
|-------------------------|---------|-------------|-------------|
| Instantaneous | x 1.00 | x 0.87 | x 1.30 |
| Minimum | x 1.00 | x 1.80 | x 3.20 |
| Sustained | x 1.00 | x 1.50 | x 2.50 |
| Max. sustained duration | 10 sec. | 5 sec. | 2 sec. |

All other times are unchanged

Note 3

Curves are drawn for Star (Wye) connected machines. For other connection the following multipliers should be applied to current values as shown :

Parallel Star = Curve current value X 2

Series Delta = Curve current value X 1.732

PI042G

Winding 311 / 0.8 Power Factor

RATINGS

| Class - Temp Rise | | Cont. F - 105/40°C | | | | Cont. H - 125/40°C | | | | Standby - 150/40°C | | | | Standby - 163/27°C | | | |
|-------------------|-------------------|--------------------|------|------|------|--------------------|------|------|------|--------------------|------|------|------|--------------------|------|------|------|
| 50 Hz | Series Star (V) | 380 | 400 | 415 | 440 | 380 | 400 | 415 | 440 | 380 | 400 | 415 | 440 | 380 | 400 | 415 | 440 |
| | Parallel Star (V) | 190 | 200 | 208 | 220 | 190 | 200 | 208 | 220 | 190 | 200 | 208 | 220 | 190 | 200 | 208 | 220 |
| | Series Delta (V) | 220 | 230 | 240 | 254 | 220 | 230 | 240 | 254 | 220 | 230 | 240 | 254 | 220 | 230 | 240 | 254 |
| | kVA | 18.0 | 18.0 | 18.0 | 17.5 | 20.0 | 20.0 | 20.0 | 19.4 | 21.6 | 21.6 | 21.6 | 21.0 | 22.0 | 22.0 | 22.0 | 21.3 |
| | kW | 14.4 | 14.4 | 14.4 | 14.0 | 16.0 | 16.0 | 16.0 | 15.5 | 17.3 | 17.3 | 17.3 | 16.8 | 17.6 | 17.6 | 17.6 | 17.0 |
| | Efficiency (%) | 80.4 | 80.7 | 80.9 | 81.1 | 80.0 | 80.4 | 80.7 | 81.0 | 79.5 | 80.0 | 80.3 | 80.8 | 79.4 | 79.9 | 80.2 | 80.8 |
| | kW Input | 17.9 | 17.8 | 17.8 | 17.3 | 20.0 | 19.9 | 19.8 | 19.2 | 21.7 | 21.6 | 21.5 | 20.8 | 22.2 | 22.0 | 21.9 | 21.1 |

| | | | | | | | | | | | | | | | | | |
|--------------|-------------------|------|------|------|------|------|------|------|------|------|------|------|------|------|------|------|------|
| 60 Hz | Series Star (V) | 416 | 440 | 460 | 480 | 416 | 440 | 460 | 480 | 416 | 440 | 460 | 480 | 416 | 440 | 460 | 480 |
| | Parallel Star (V) | 208 | 220 | 230 | 240 | 208 | 220 | 230 | 240 | 208 | 220 | 230 | 240 | 208 | 220 | 230 | 240 |
| | Delta (V) | 240 | 254 | 266 | 277 | 240 | 254 | 266 | 277 | 240 | 254 | 266 | 277 | 240 | 254 | 266 | 277 |
| | kVA | 19.8 | 21.0 | 21.0 | 21.0 | 22.0 | 23.3 | 23.3 | 23.3 | 23.8 | 25.2 | 25.2 | 25.2 | 24.2 | 25.7 | 25.7 | 25.7 |
| | kW | 15.8 | 16.8 | 16.8 | 16.8 | 17.6 | 18.6 | 18.6 | 18.6 | 19.0 | 20.2 | 20.2 | 20.2 | 19.4 | 20.6 | 20.6 | 20.6 |
| | Efficiency (%) | 78.9 | 79.3 | 79.5 | 79.7 | 78.8 | 79.2 | 79.5 | 79.8 | 78.6 | 79.0 | 79.4 | 79.7 | 78.5 | 78.9 | 79.3 | 79.6 |
| | kW Input | 20.1 | 21.2 | 21.1 | 21.1 | 22.3 | 23.5 | 23.4 | 23.4 | 24.2 | 25.5 | 25.4 | 25.3 | 24.7 | 26.1 | 25.9 | 25.8 |

DIMENSIONS

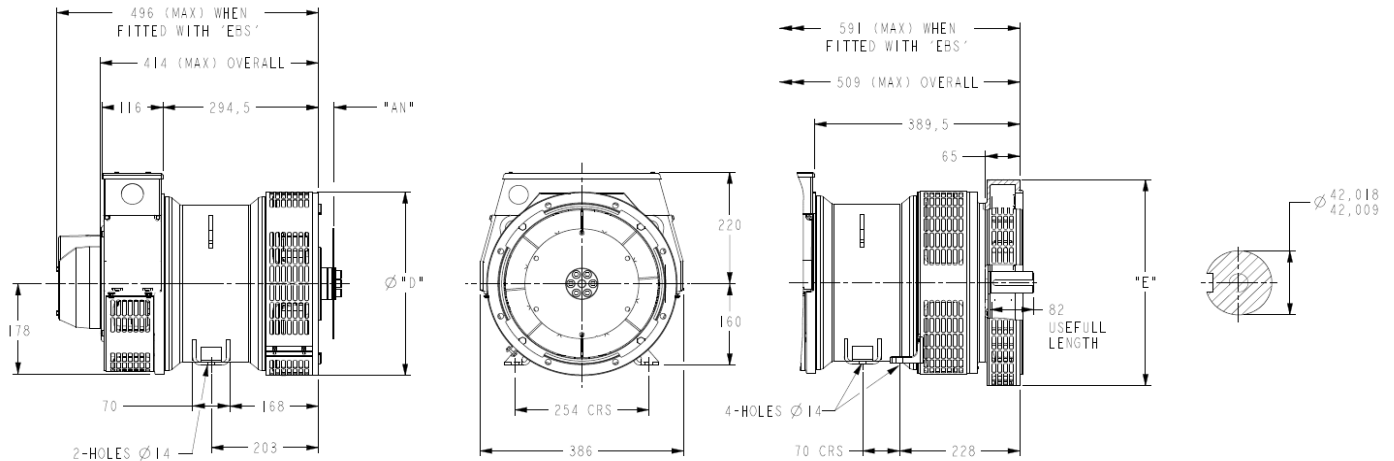

| COUPLING DISC | |
|---------------|-------|
| SAE | "AN" |
| 6.5 | 30.2 |
| 7.5 | 30.2 |
| 8 | 62 |
| 10 | 53.8 |
| 11.5 | 39.68 |

| 1-BRG ADAPTOR | |
|---------------|-----|
| SAE | "D" |
| 5 | 361 |
| 4 | 405 |
| 3 | 451 |
| 2 | 489 |

8-HOLES SPACED AS 12
8-HOLES SPACED AS 12

| 2-BRG ADAPTOR | |
|---------------|-----|
| SAE | "E" |
| 5 | 359 |
| 4 | 406 |
| 3 | 455 |
| 2 | 493 |