

# STAMFORD<sup>®</sup>

## HV 804 X WDG 61 - Technical Data Sheet

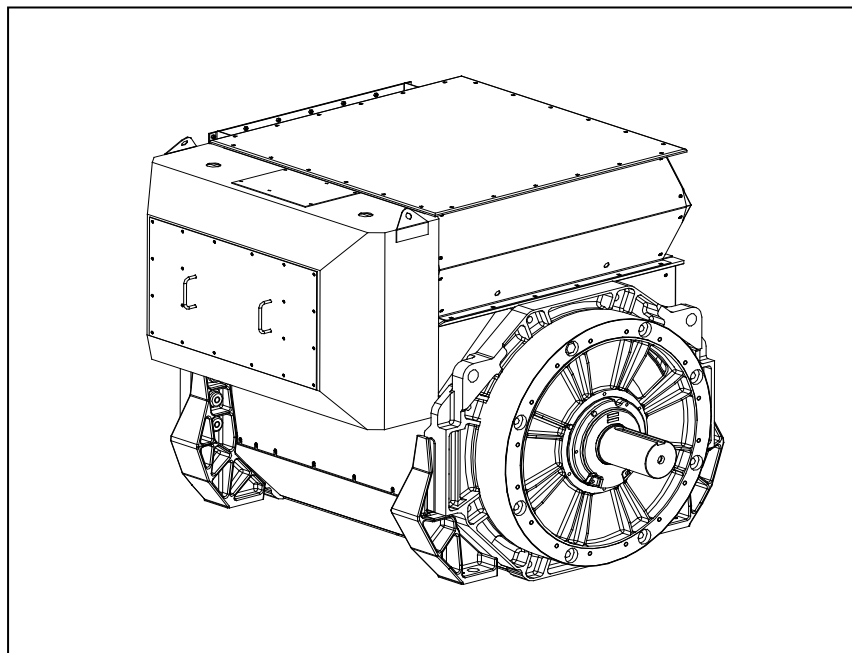

# FRAME HV 804 X

## SPECIFICATIONS & OPTIONS

**STAMFORD**

### STANDARDS

STAMFORD AC generators are designed to meet the performance requirements of IEC EN 60034-1. Other international standards, including BS5000, VDE 0530, NEMA MG1-32, AS1359, CSA C22.2, UL and CE; as well as a wide range of international Marine Certification Approvals, can be met on request. For clarification regarding compliance please contact Cummins Generator Technologies

### DESCRIPTION

The STAMFORD PI range of synchronous ac generators are brushless with a rotating field. They are separately excited by the STAMFORD Permanent Magnet Generator (PMG). This is a shaft mounted, high frequency, pilot exciter which provides a constant supply of clean power via the Automatic Voltage Regulator (AVR) to the main exciter. The main exciter output is fed to the main rotor, through a full wave bridge rectifier, protected by surge suppression.

### VOLTAGE REGULATORS

The P range generators complete with a PMG are available with one AVR. The AVR has soft start voltage build up and built in protection against sustained over-excitation, which will de-excite the generator after a minimum of 8 seconds. Underspeed protection (UFRO) is also provided on both AVRs. The UFRO will reduce the generator output voltage proportional to the speed of the generator below a pre-settable level.

The **MA330 AVR** is 3 phase rms sensed with a voltage regulation of 0.5% rms (see the note on regulation). The UFRO circuit has adjustable slope and dwell for controlled recovery from step loads. An over voltage protection circuit will shutdown the output device of the AVR, it can also trip an optional excitation circuit breaker if required. As an option, short circuit current limiting is available with the addition of current transformers.

The MA330 AVR needs a generator mounted current transformer to provide quadrature droop characteristics for load sharing during parallel operation. Provision is also made for the connection of the STAMFORD power factor controller, for embedded applications, and a remote voltage trimmer.

### WINDINGS & ELECTRICAL PERFORMANCE

All generator stators are wound to 2/3 pitch. This eliminates triplen (3rd, 9th, 15th ...) harmonics on the voltage waveform and is found to be the optimum design for trouble-free supply of non-linear loads. The 2/3 pitch design avoids excessive neutral currents sometimes seen with higher winding pitches. A fully connected damper winding reduces oscillations during paralleling. This winding, with the 2/3 pitch and carefully selected pole and tooth designs, ensures very low levels of voltage waveform distortion.

### TERMINALS & TERMINAL BOX

Standard generators feature a main stator with 6 ends brought out to the terminals, which are mounted on the frame at the non-drive end of the generator. A sheet steel terminal box contains the AVR and provides ample space for the customers' wiring and gland arrangements. It has removable panels for easy access.

### SHAFT & KEYS

All generator rotors are dynamically balanced to better than BS6861:Part 1 Grade 2.5 for minimum vibration in operation. Two bearing generators are balanced with a half key.

### INSULATION/IMPREGNATION

The insulation system is class 'F'. All wound components are impregnated with materials and processes designed specifically to provide the high build required for static windings and the high mechanical strength required for rotating components.

### QUALITY ASSURANCE

Generators are manufactured using production procedures having a quality assurance level to BS EN ISO 9001.

### NOTE ON REGULATION

The stated voltage regulation may not be maintained in the presence of certain radio transmitted signals. Any change in performance will fall within the limits of Criteria 'B' of EN 61000-6-2:2001. At no time will the steady-state voltage regulation exceed 2%.

NB Continuous development of our products entitles us to change specification details without notice, therefore they must not be regarded as binding.

Front cover drawing is typical of the product range.

**FRAME HV 804 X  
WINDING 61**

RATINGS	REFER TO SALES AND SERVICE BRIEFING
MAXIMUM ALTITUDE	1000 METRES ABOVE SEA LEVEL
MAXIMUM AMBIENT TEMPERATURE	40° C

CONTROL SYSTEM SERIES 3	SEPARATELY EXCITED BY P.M.G.
A.V.R.	FULL WAVE RECTIFIED
VOLTAGE REGULATION	± 0.5% WITH 4% ENGINE GOVERNING
SUSTAINED SHORT CIRCUIT	REFER TO SHORT CIRCUIT DECREMENT CURVES OF THIS SECTION

INSULATION SYSTEM	CLASS F
PROTECTION	IP23 STANDARD
RATED POWER FACTOR	0.8
STATOR WINDING	DOUBLE LAYER LAP
WINDING PITCH	2/3
WINDING LEADS	6
R.F.I. SUPPRESSION	BS EN 50081/2-1/2 VDE 0875G VDE 0875N For other standards apply to the factory
WAVEFORM DISTORTION	NO LOAD < 1.5% NON-DISTORTING BALANCED LINEAR LOAD < 3.0%
MAXIMUM OVERSPEED	2250 Rev/Min
BEARING DRIVE END	ISO 6236 C3
BEARING NON DRIVE END	ISO 6324 C3
EFFICIENCY	REFER TO EFFICIENCY CURVES OF THIS SECTION

FREQUENCY	50Hz		
TELEPHONE INTERFERENCE	THF < 2%		
COOLING AIR	3.75 m <sup>3</sup> /sec		
VOLTAGE STAR (Y)	6300	6600	6900
KVA BASE RATING FOR REACTANCE VALUES	3699	3875	3875
X <sub>d</sub> DIRECT AXIS SYNCHRONOUS	2.51	2.40	2.20
X' <sub>d</sub> DIRECT AXIS TRANSIENT	0.190	0.181	0.166
X'' <sub>d</sub> DIRECT AXIS SUB-TRANSIENT	0.139	0.132	0.121
X <sub>q</sub> QUADRATURE AXIS REACTANCE	1.76	1.680	1.54
X'' <sub>q</sub> QUAD. AXIS SUB-TRANSIENT	0.265	0.253	0.231
X <sub>L</sub> LEAKAGE REACTANCE	0.093	0.089	0.081
X <sub>2</sub> NEGATIVE PHASE SEQUENCE	0.202	0.193	0.177
X <sub>0</sub> ZERO PHASE SEQUENCE	0.035	0.033	0.030

REACTANCES ARE SATURATED	VALUES ARE PER UNIT AT RATING AND VOLTAGE INDICATED		
T' <sub>d</sub> TRANSIENT TIME CONSTANT	0.226		
T'' <sub>d</sub> SUB-TRANSIENT TIME CONSTANT	0.016		
T' <sub>do</sub> O.C. FIELD TIME CONSTANT	5.10		
T <sub>a</sub> ARMATURE TIME CONSTANT	0.09		
SHORT CIRCUIT RATIO	1/X <sub>d</sub>		

STATOR WINDING RESISTANCE (L-N)	0.0717
ROTOR WINDING RESISTANCE	1.630
EXCITER STATOR FIELD RESISTANCE	17.00
EXCITER ROTOR RESISTANCE (L-L)	0.092
PMG STATOR RESISTANCE (L-L)	2.700
	RESISTANCE VALUES ARE IN OHMS AT 20° C

NO LOAD EXCITATION VOLTAGE	15.0
FULL LOAD EXCITATION VOLTAGE	67.0

Continuous development of our products entitles us to change specification details without notice, therefore they must not be regarded as binding.

**THREE PHASE EFFICIENCY CURVES**

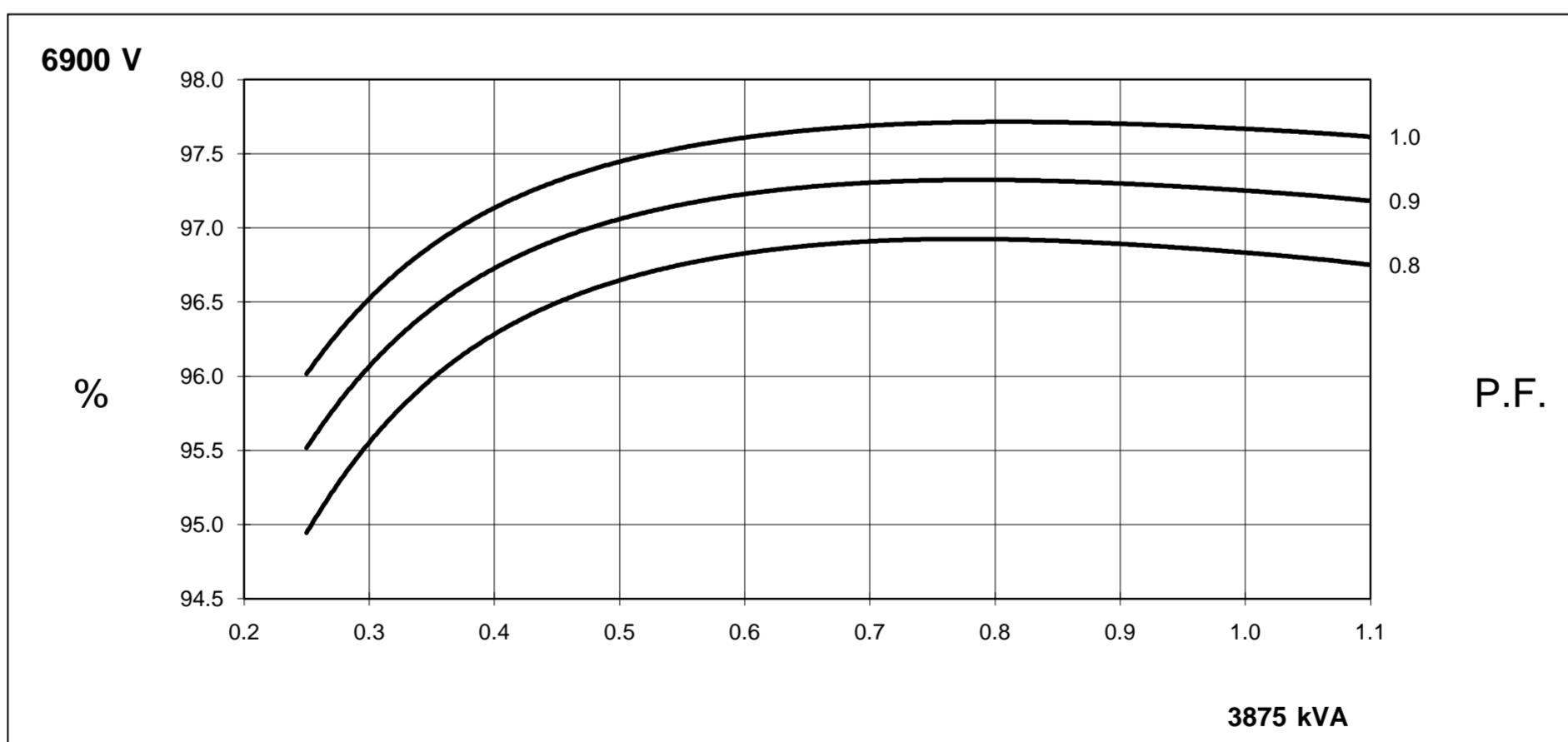
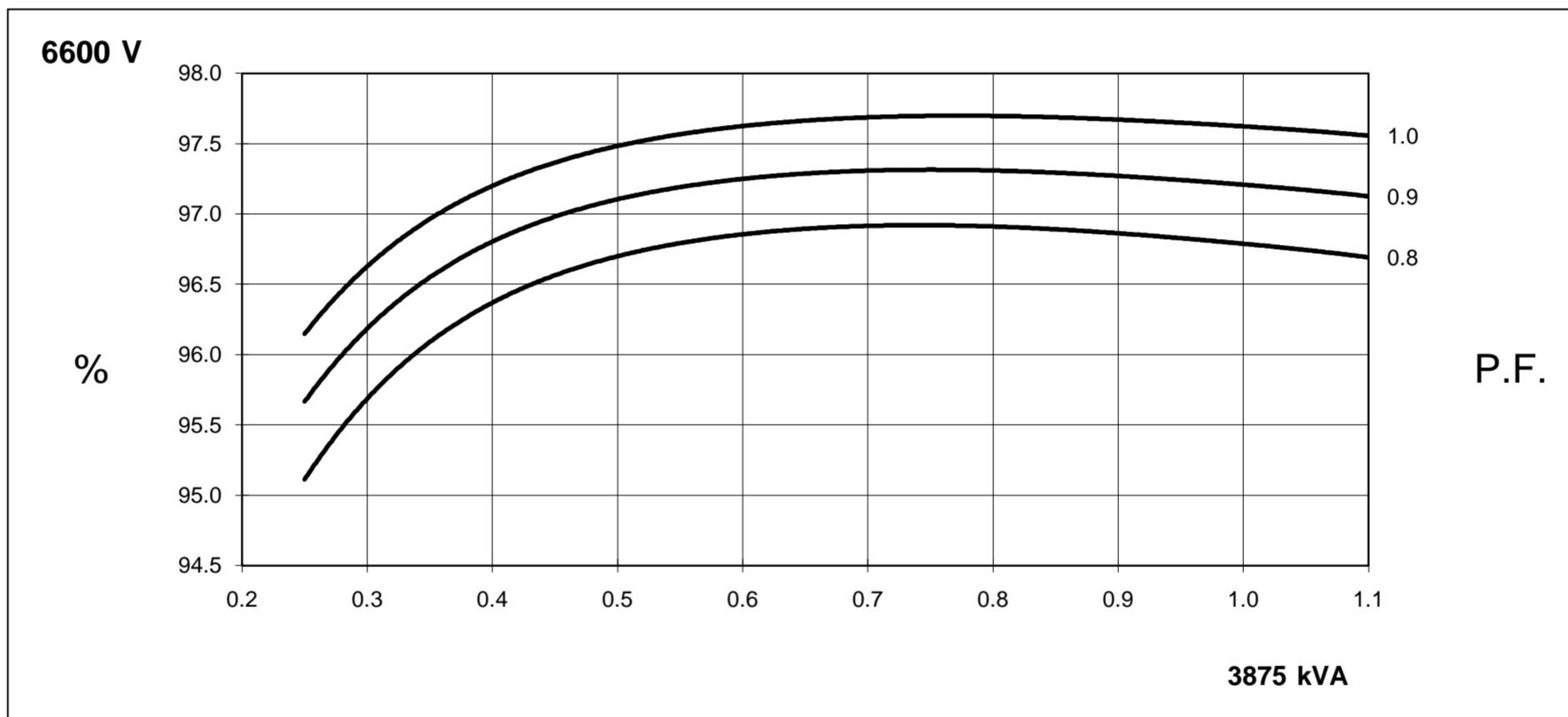
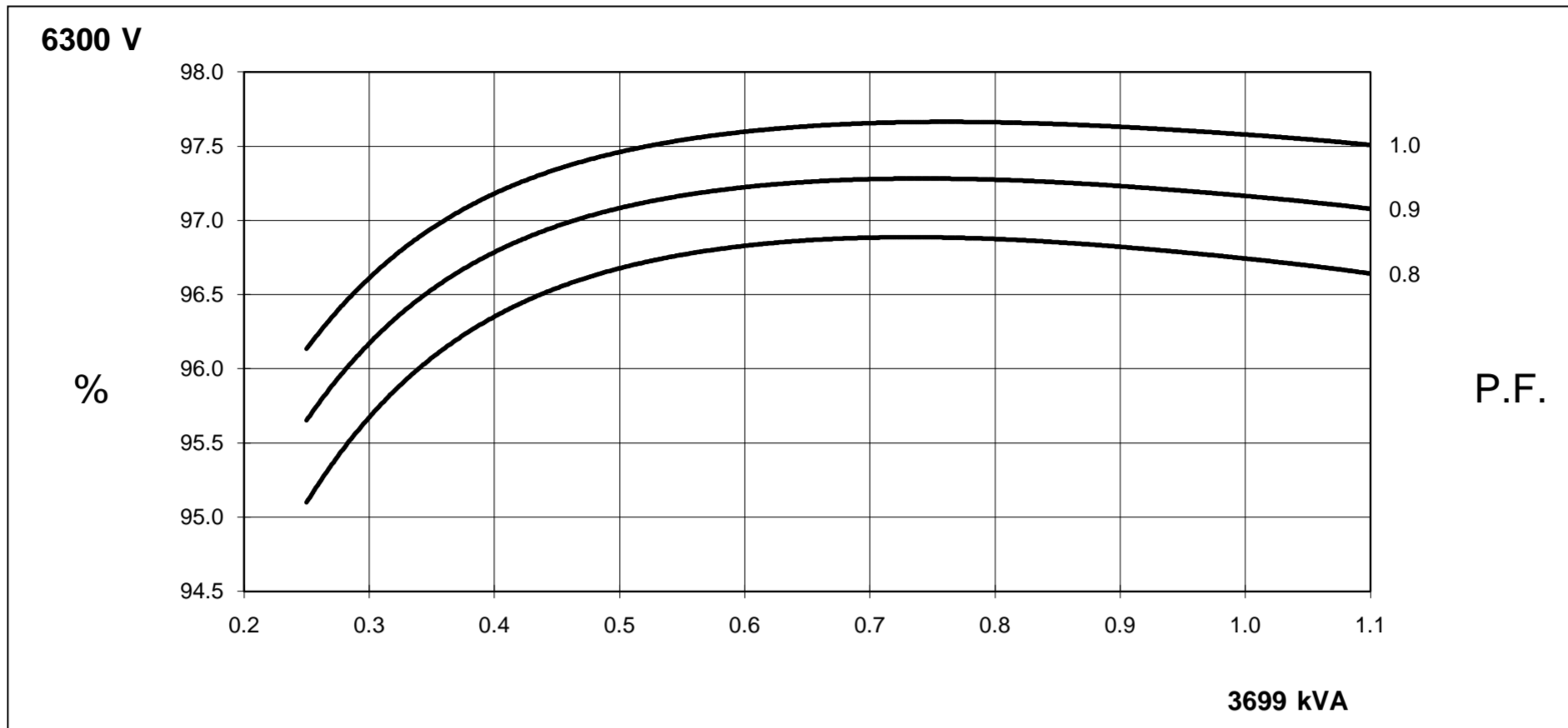

**FULL WAVE RECTIFIED AVR  
LOCKED ROTOR MOTOR STARTING CURVE**

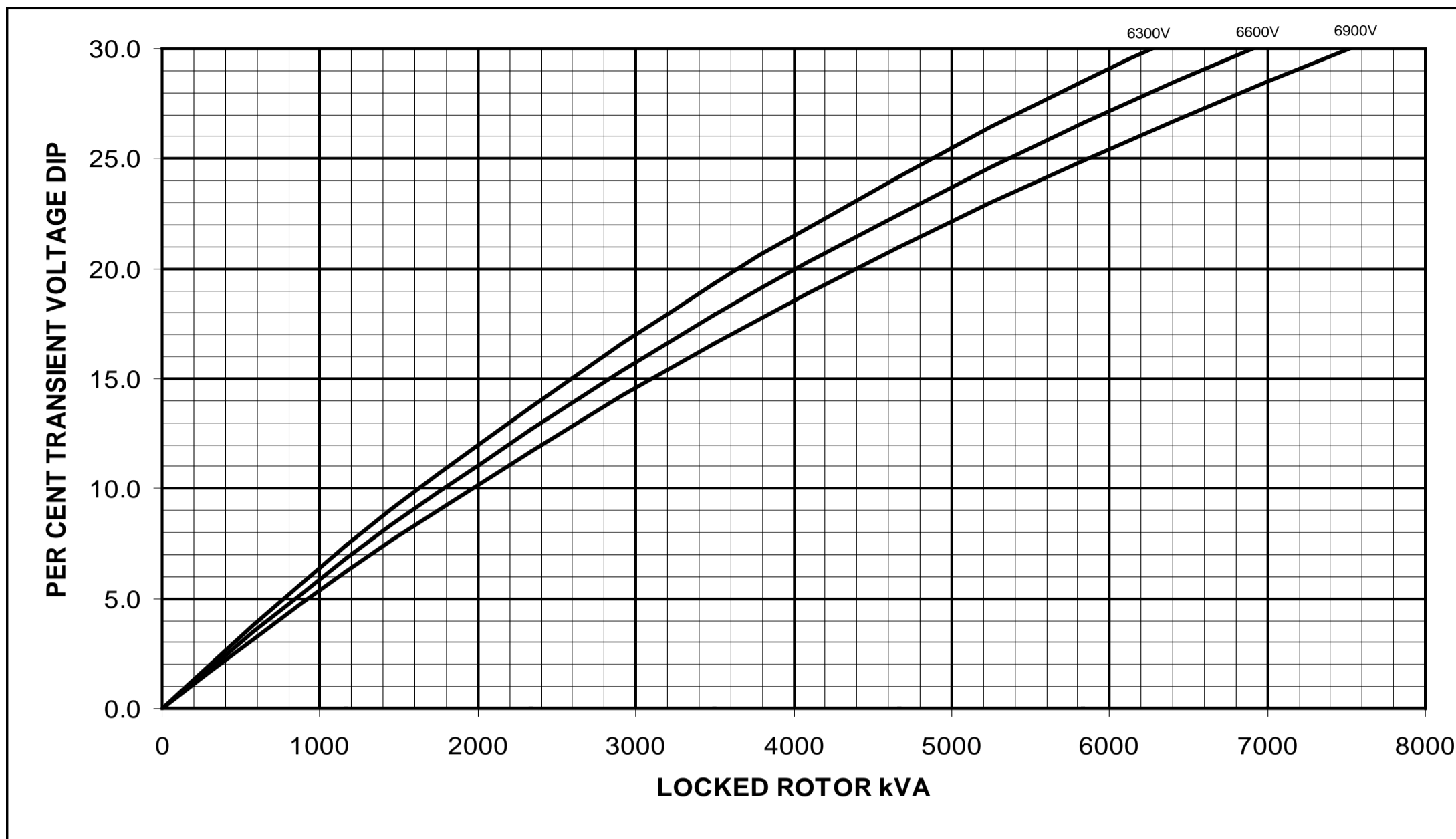

**FRAME HV 804 X WDG 61 50Hz**

**Three Phase Short Circuit Decrement Curve  
No- Load Excitation at Rated Speed**

Based on series star (wye) connection

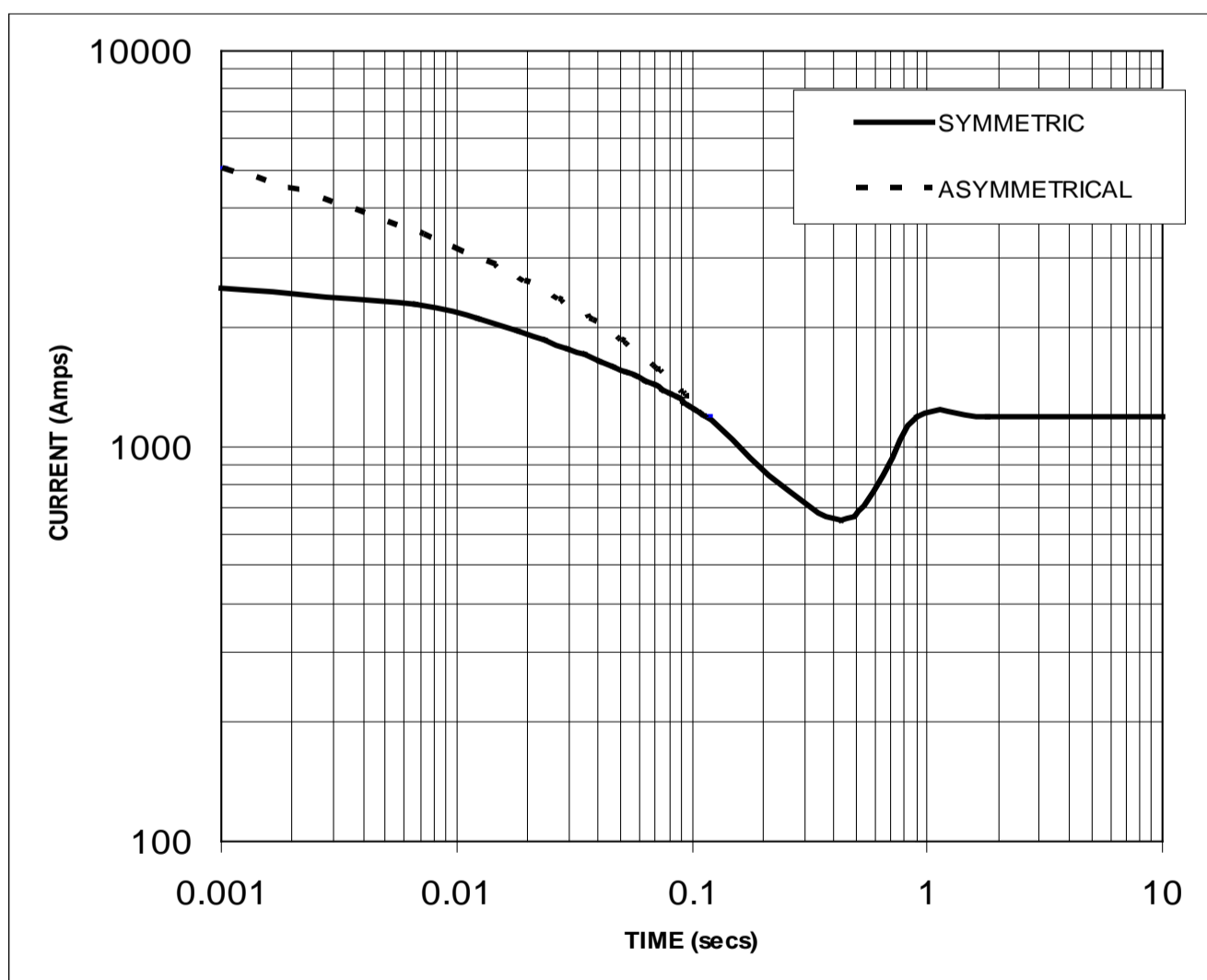

NOTE 1  
THE FOLLOWING MULTIPLICATION FACTORS SHOULD BE USED TO ADJUST THE VALUES FROM CURVES BETWEEN THE 0.001 SECONDS AND THE MINIMUM CURRENT POINT IN RESPECT OF NOMINAL OPERATING VOLTAGE

VOLTAGE	FACTOR
6300V	X 1.00
6600V	X 1.05

THE SUSTAINED CURRENT VALUE IS CONSTANT IRRESPECTIVE OF VOLTAGE LEVEL

NOTE 2  
THE FOLLOWING MULTIPLICATION FACTORS SHOULD BE USED TO CONVERT THE VALUES CALCULATED IN ACCORDANCE WITH NOTE 1 TO THOSE APPLICABLE TO THE VARIOUS TYPES OF SHORT CIRCUIT

	3 PHASE	2 PHASE L-L	1 PHASE L-N
INSTANTANEOUS	X 1.0	X 0.87	X 1.30
MINIMUM	X 1.0	X 1.80	X 3.20
SUSTAINED	X 1.0	X 1.50	X 2.50
MAX SUSTAINED DURATION	10 SEC	5 SEC	2 SEC
ALL OTHER TIMES ARE UNCHANGED			

SUSTAINED SHORT CIRCUIT = 1186 Amps

FRAME HV 804 X  
WINDING 61                      0.8 Power Factor



**RATINGS**

Class - Temp Rise		Cont. F - 105/40°C			Cont. H - 125/40°C			Class F Standby - 125/40°C			Class F Standby - 138/27°C		
<b>50Hz</b>	Star (V)	6300	6600	6900	6300	6600	6900	6300	6600	6900	6300	6600	6900
	kVA	3699	3875	3875	N/A	N/A	N/A	3952	4140	4140	4105	4300	4300
	kW	2959	3100	3100	N/A	N/A	N/A	3162	3312	3312	3284	3440	3440
	Efficiency (%)	96.7	96.8	96.8	N/A	N/A	N/A	96.7	96.7	96.8	96.6	96.7	96.8
	kW Input	3059	3203	3201	N/A	N/A	N/A	3271	3424	3423	3398	3558	3555
<b>60Hz</b>	Star (V)	N/A	N/A	N/A	N/A	N/A	N/A	N/A	N/A	N/A	N/A	N/A	N/A
	kVA	N/A	N/A	N/A	N/A	N/A	N/A	N/A	N/A	N/A	N/A	N/A	N/A
	kW	N/A	N/A	N/A	N/A	N/A	N/A	N/A	N/A	N/A	N/A	N/A	N/A
	Efficiency (%)	N/A	N/A	N/A	N/A	N/A	N/A	N/A	N/A	N/A	N/A	N/A	N/A
	kW Input	N/A	N/A	N/A	N/A	N/A	N/A	N/A	N/A	N/A	N/A	N/A	N/A

**TYPICAL DIMENSIONS - Further arrangements available - please refer to factory**

P80 R/S/T CORES

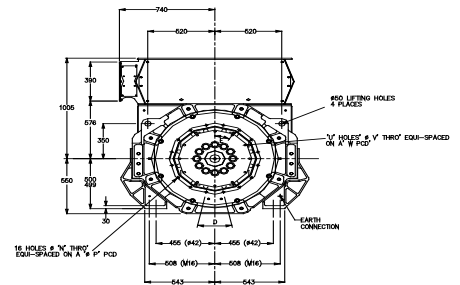
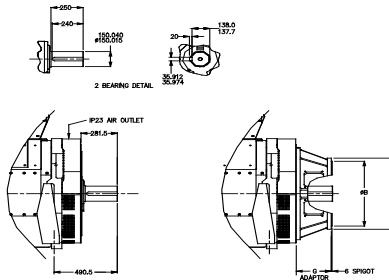
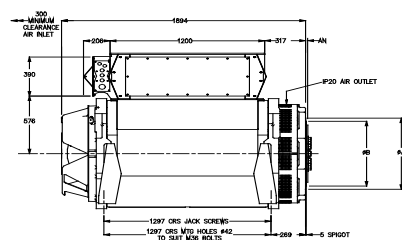

SAE	A	B	N	P	D
SAE 0	711	647.7	14	679.5	22.5"
SAE 00	883	787.4	14	851.0	22.5"

SAE	AN	C	U	V	W	E
18	15.9	571.4	12	16.7	543.0	30°
21	0	673.0	12	16.7	641.3	30°
24	0	733.3	12	20.7	692.0	30°

	SAE	G
P80 R/S/T	0	271.5
P80 R/S/T	00	271.5
P80 W/X	0	271.5
P80 W/X	00	329.0

SAE	A	B	N	P	D
SAE 0	711	647.7	14	679.5	22.5"
SAE 00	883	787.4	14	851.0	22.5"

P80 W/X CORES

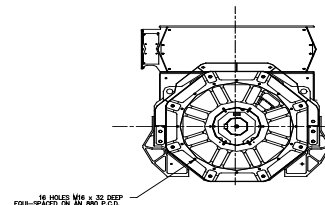
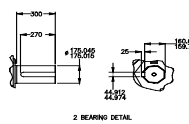
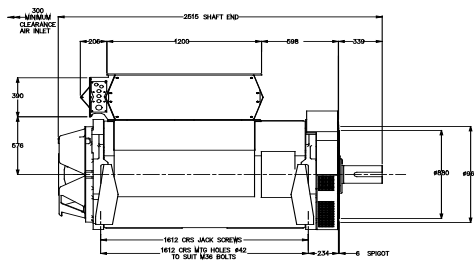

Barnack Road • Stamford • Lincolnshire • PE9 2NB  
Tel: 00 44 (0)1780 484000 • Fax: 00 44 (0)1780 484100