

Electrical Characteristics										
Frequency	Hz	50				60				
Voltage (series star)	V	380	400	415	440	415	440	460	480	
Rated power class H	kVA	180	180	180	165	210	220	220	220	
	kW	144	144	144	132	168	176	176	176	
Rated power class F	kVA	170	170	170	155	195	205	205	205	
	kW	136	136	136	124	156	164	164	164	
Regulation with UVR6		±1 % with any power factor and speed variations between -5% +30%								
Insulation class		H								
Execution		Brushless								
Stator winding		12 ends								
Rotor		with damping cage								
Efficiencies class H	4/4	%	92,4	92,5	92,2	92	92,8	93,3	93,4	93,5
(see graph. for details)	3/4	%	92,4	92,7	92,6	92,3	93,1	93,3	93,5	93,7
	2/4	%	91,3	91,4	91,4	91,2	92,1	92,2	92,3	92,4
	1/4	%	89,2	89	88,8	88,6	90,2	90,2	90,2	90
Reactances (f. l.cl. F)	Xd	%	229,4	207	192,3	156,8	264,3	246,3	225,4	207
	Xd'	%	11,3	10,2	9,5	7,7	13,0	12,1	11,1	10,2
	Xd''	%	6,4	5,8	5,4	4,4	7,4	6,9	6,3	5,8
	Xq	%	113,0	102	94,8	77,3	130,3	121,4	111,1	102
	Xq'	%	113,0	102	94,8	77,3	130,3	121,4	111,1	102
	Xq''	%	22,9	20,7	19,2	15,7	26,4	24,6	22,5	20,7
	X ₂	%	15,0	13,5	12,5	10,2	17,2	16,1	14,7	13,5
	X ₀	%	3,1	2,8	2,6	2,1	3,6	3,3	3,0	2,8
Short Circuit Ratio	Kcc		0,39	0,42	0,60	0,97	0,28	0,35	0,39	0,42
Time Constants	Td'	sec.	0,075							
	Td''	sec.	0,012							
	Tdo'	sec.	0,80							
	Tα	sec.	0,016							
Short Circuit Current Capacity		%	>300				>350			
Excitation at no load	Amp.		0,65	0,7	0,8	1,1	0,35	0,5	0,6	0,65
Excitation at full load	Amp.		2,9	3,1	3,4	3,5	2,5	2,7	2,8	3
Overload (long-term)		%	1 hour in a 6 hours period 110% rated load							
Overload per 20 sec.		%	300							
Stator Winding Resistance (20°C)	Ω		0,0134							
Rotor Winding Resistance (20°C)	Ω		4,510							
Exciter Resistance (20 °C)	Ω		Rotor : 0,685				Stator : 15,28			
Heat dissipation at f.l.cl.H	W		11844	11676	12182	11478	13034	12639	12437	12235
Telephone Interference			FHT < 2%				TIF < 40			
Radio interference			EN50081-1, EN50082-1, VDE0875K. For others standards apply to factory							
Waveform Distors.(THD) at f. load	LL/LN %		2,8 / 2,7							
Waveform Distors.(THD) at no load	LL/LN %		3,1 / 3							
Mechanical characteristics										
Protection			IP 21 (other protection on request)							
DE bearing			6318.2RS							
NDE bearing			6314.2RS							
Weight of wound stator assembly	kg		177							
Weight of wound rotor assembly	kg		109							
Weight of complete generator	kg		525							
Maximun overspeed	rpm		2250							
Unbalanced magnetic pull at f.l.cl.F	kN/mm		4,4							
Cooling air requirement	m ³ /min		32				39			
Inertia Constant (H)	sec.		0,122				0,144			
Noise level at 1m/7m	dB(A)		82 / 69				86 / 73			

50 Hz

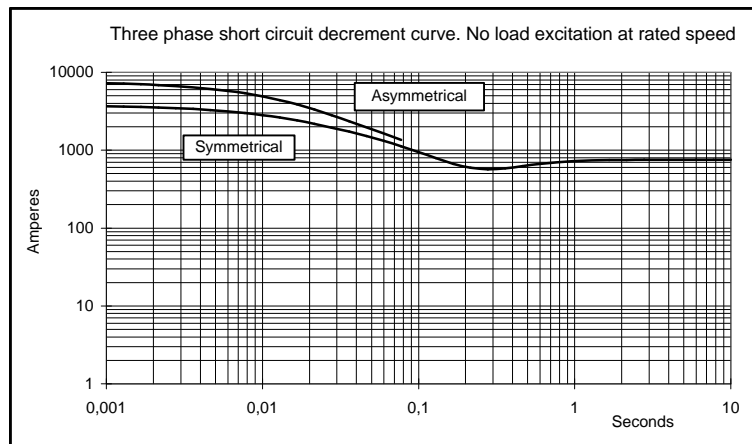

60 Hz

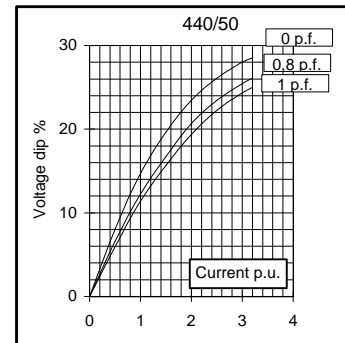
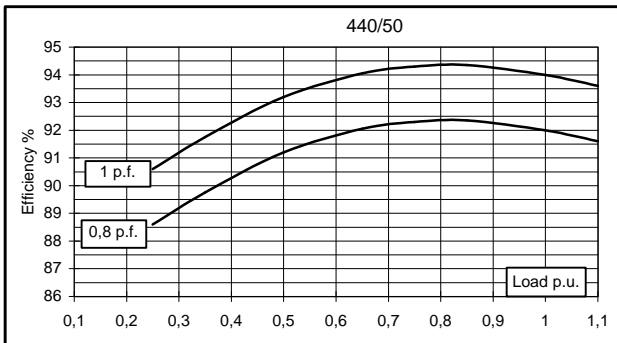
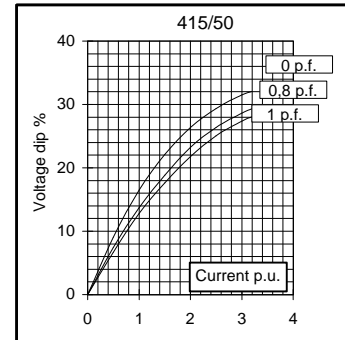
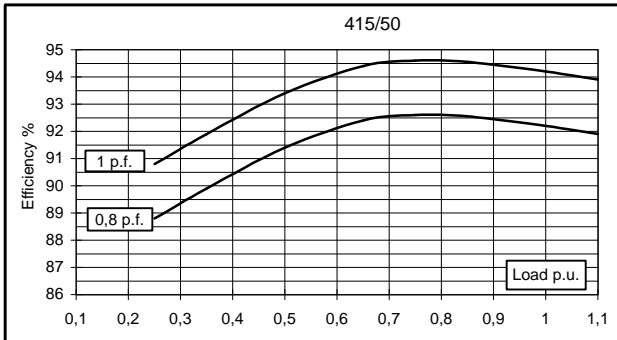
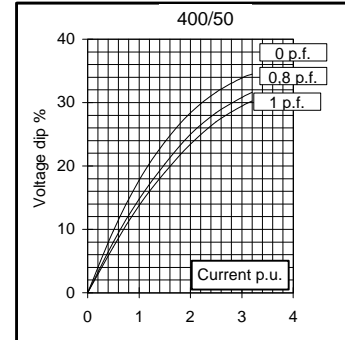
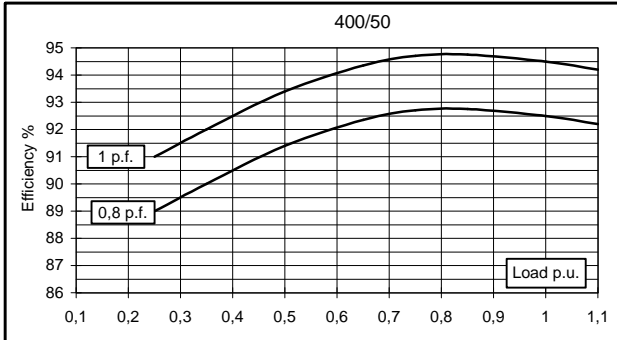
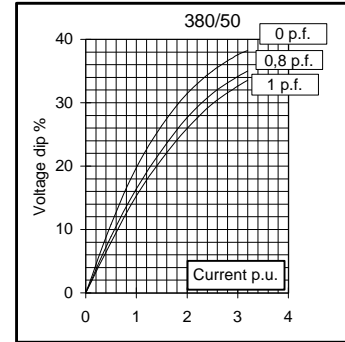
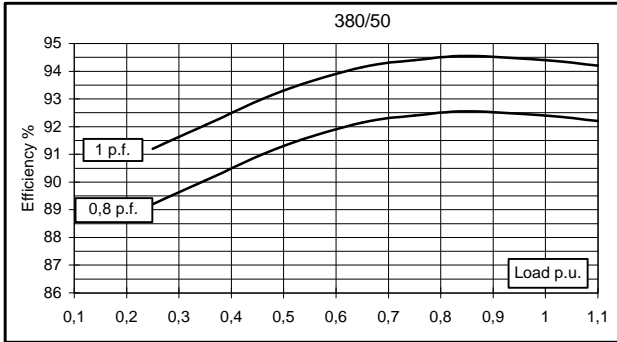
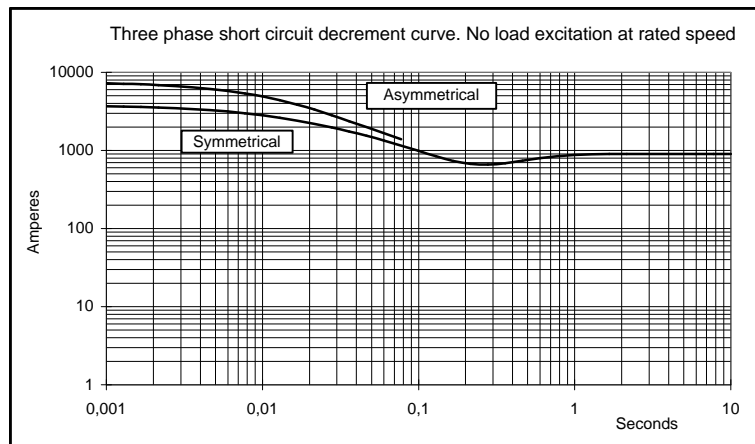
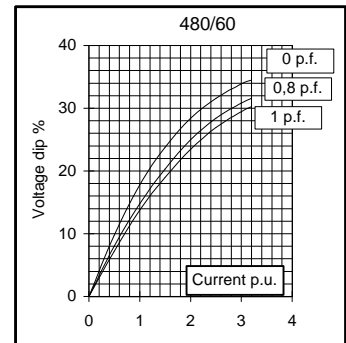
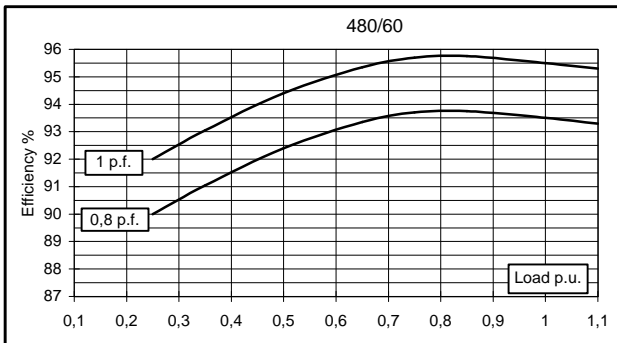
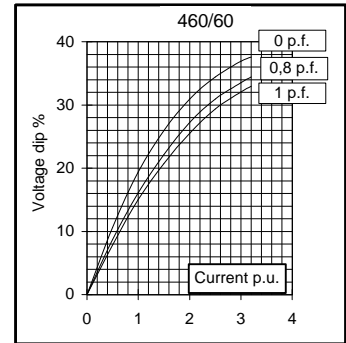
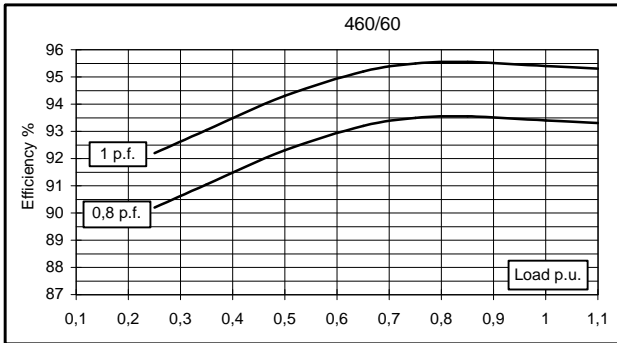
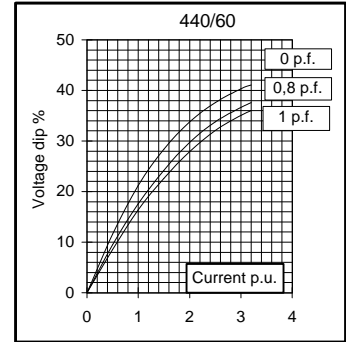
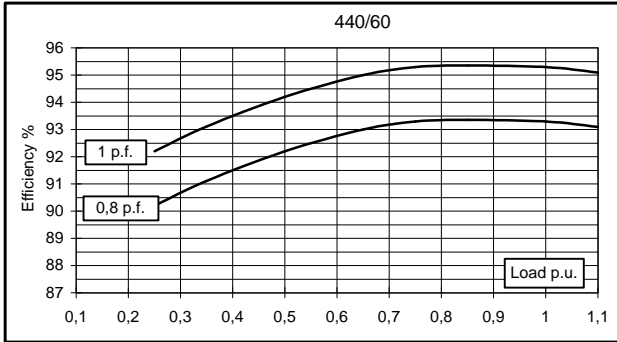
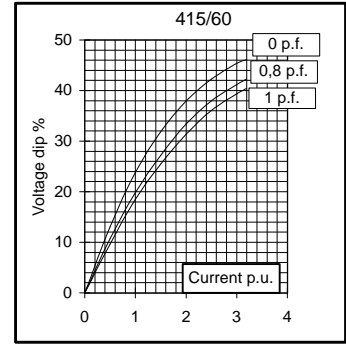
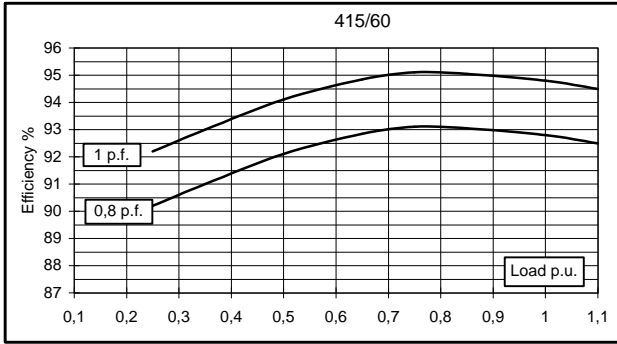

TWO BEARING MOMENTS OF INERTIA

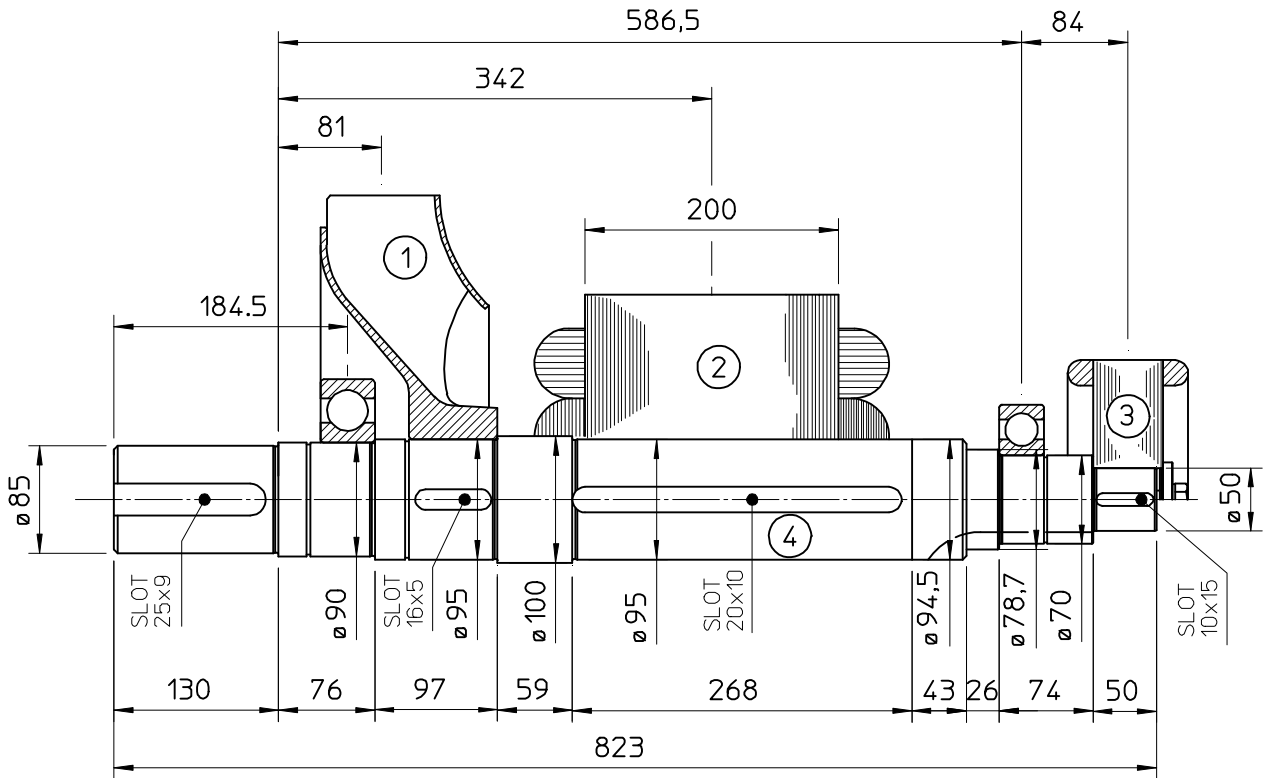

COMPONENT	WEIGHT kg	J kgm ²
1 FAN	6,1	0,1887
2 MAIN ROTOR	109	1,4587
3 EX. ROTOR	14,5	0,0874
4 SHAFT	38,5	0,0397
TOTAL	168,1	1,7745

TWO BEARING DIMENSIONS

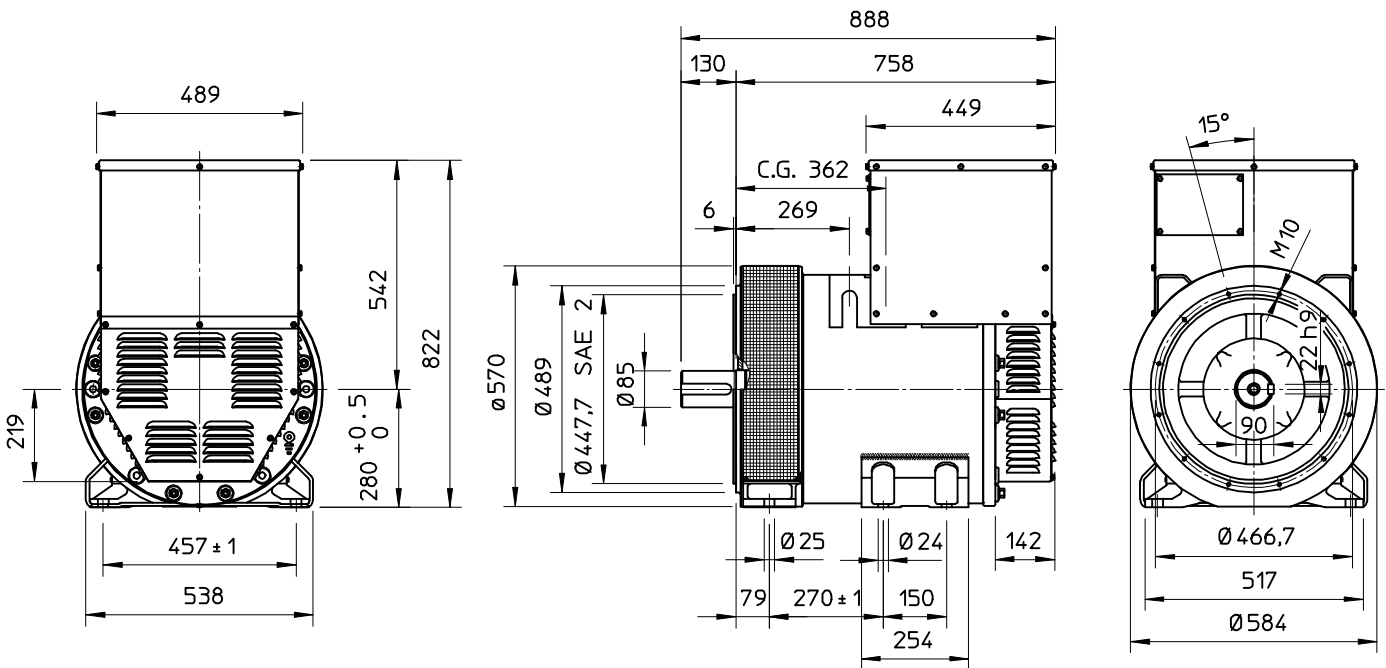

C.G = GRAVITY CENTER

SINGLE BEARING MOMENTS OF INERTIA

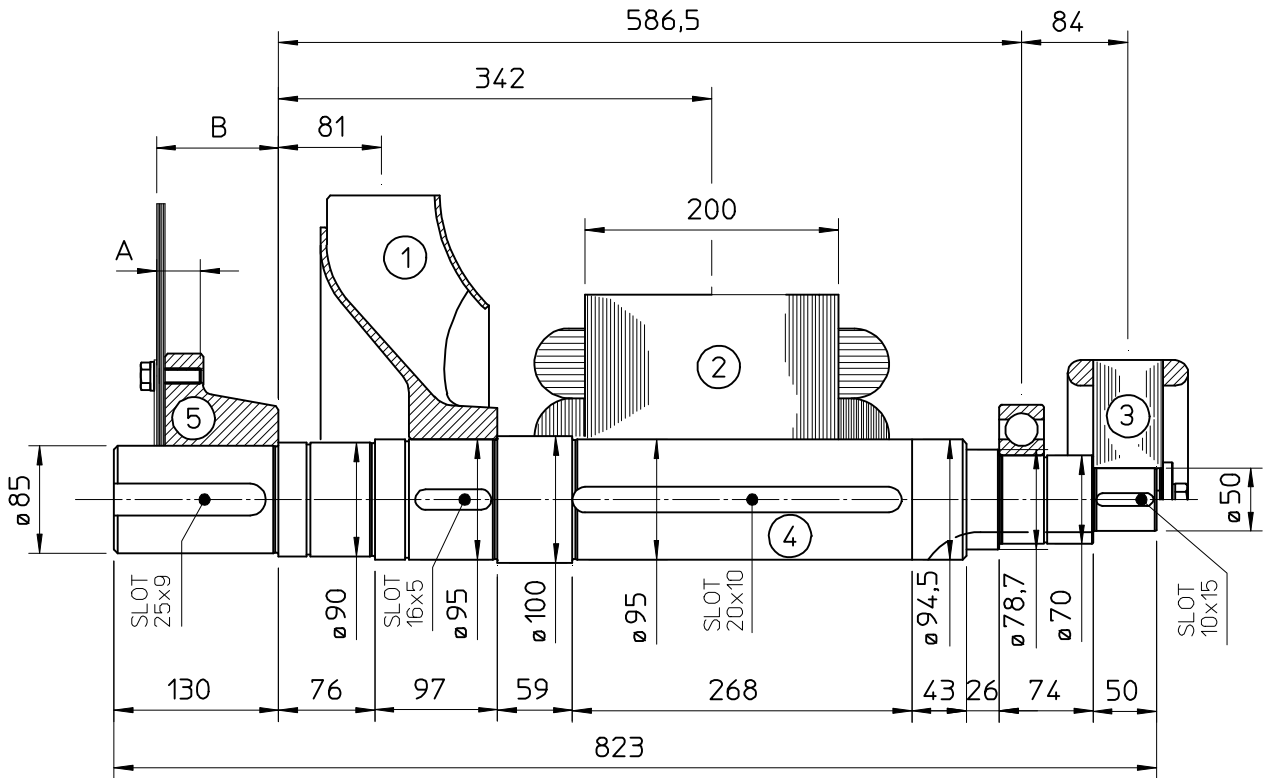

COMPONENT	WEIGHT kg	J kgm ²
1 FAN	6,1	0,1887
2 MAIN ROTOR	109	1,4587
3 EX. ROTOR	14,5	0,0874
4 SHAFT	38,5	0,0397
TOTAL	168,1	1,7745

SAE No	SHAFTS COUPLING FLEX PLATE			
	A	B	WEIGHT kg	J kgm ²
5				
11.5	41.1	110.4	22,7	0,306
14	34.7	96.4	22,7	0,306

SINGLE BEARING DIMENSIONS

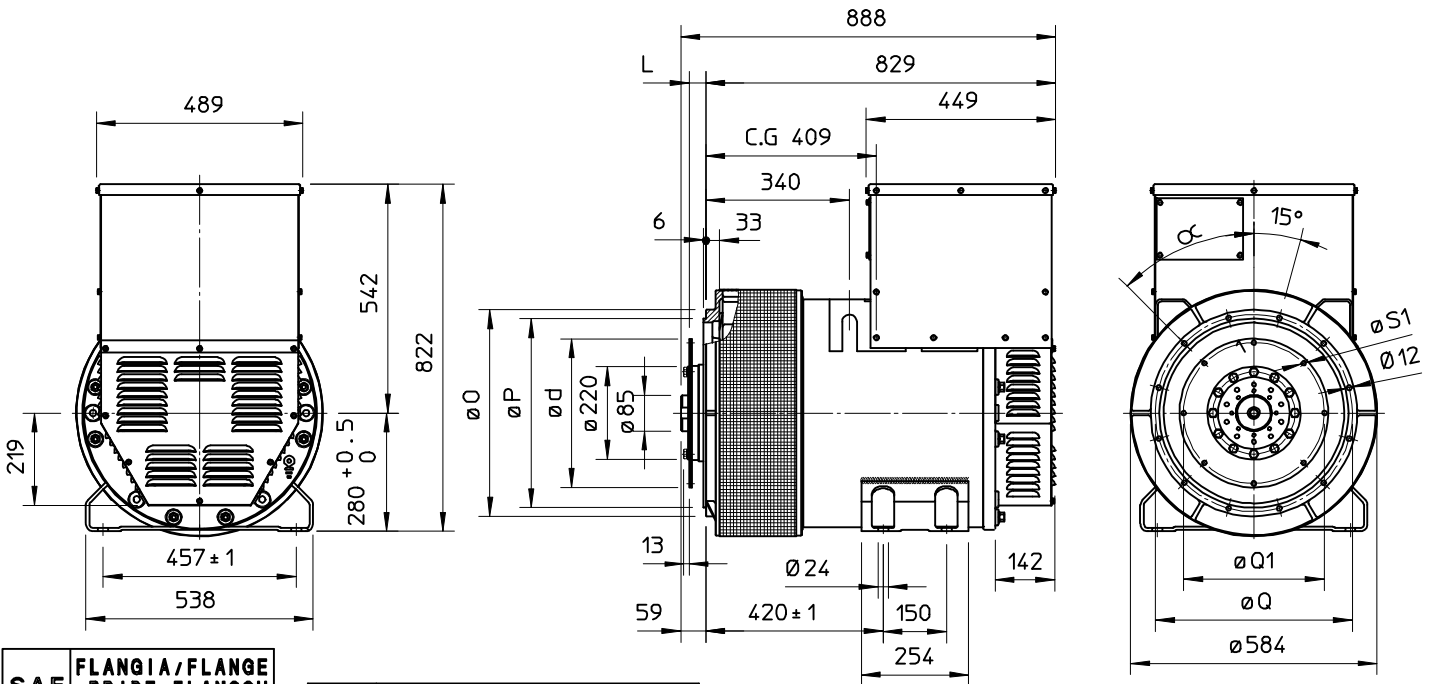

SAE N.	FLANGIA/FLANGE BRIDE/FLANSCH		
	O	P	Q
3	451	409,6	428,6
2	489	447,7	466,7
1	552	511,2	530,2
1/2	648	584,2	619,1

SAE N.	GIUNTI A DISCHI DISC COUPLING DISQUE DE MONOPALIER SCHEIBENKUPPLUNG					
	L	d	Q1	n. fori	S1	α1
11 1/2	39,6	352,42	333,37	8	11	45°
14	25,4	466,72	438,15	8	14	45°

C.G = GRAVITY CENTER