

ژنراتور : Mecc Alte

موتور دیزل : Deutz

Standby		Prime		دیزل ژنراتور
KVA	KW	KVA	KW	
198	158.4	180	144	



موتور دیزل

Manufacturer	Deutz	تولید کننده
Type	BF6M1013FC-G2	تیپ
Number of cylinders	4	تعداد سیلندر ها
Cylinder arrangement	in-line	آرایش سیلندر ها
Cycle	4 stroke	چرخه
Aspiration	Turbo charged CAC	سیستم تنفس
Bore × Stroke , mm	105X130	قطر سیلندر × کورس پیستون
Displacement , Liters	4.76	جا به جایی
Speed Governor	Mechanical	سرعت گاورنر
Cooling System	water-cooled	سیستم فنک کننده
Frequency	50Hz	فرکانس

ژنراتور

Manufacturer	Mecc alte	تولید کننده
Type	ECO38-1S	تیپ
Exciter type	Brushless, Self-excited	نوع کانتر
Power factor	0.8	ضریب قدرت
Voltage	380	ولتاژ
Frequency	50 Hz	فرکانس
Speed, Rpm	1500	سرعت
Insulation class	H	کلاس عایق
Protection class	IP23	کلاس حفاظتی
Excitation	Brushless	سیستم تمریک

GENERAL INFORMATION

DIESEL GENERATOR SET

Model	DE200D5 / DE220D6	
Motor	DEUTZ BF6M1013FCG2	
Alternator	STAMFORD OR LEROY SOMER	
Speed Control type	Heizmann EMR	
Phase	Three	
Fuel Tank Capacity	370 L	
System Voltage	12V	
Frequency	50HZ	60HZ
Air Flow	11520m ³ /h	14760m ³ /h
Combustion air flow	743.9m ³ /h	931.4m ³ /h
Exhaust air flow	2108m ³ /h	2526m ³ /h
Exhaust Temperature	540°C	515°C

Engine

Maximum output(kw)	160KW(50Hz)	176KW(60Hz)
Number of Cylinders	Inline 6	
Aspiration	Turbo charged, CAC	
Cycle	6	
Fuel Type	Diesel	
Combustion Type	Direct Injection	
Cooling Type	Water cooled	
Bore	108mm	
Stroke	130mm	
Displacement	7.15L	
Compression Ratio	18.1:1	
Lubrication Capacity	20 liter	
Coolant Capacity	9.8 liter	

FUEL CONSUMPTION	1500 RPM	1800 RPM
	L/hr	L/hr
100% Prime Power(1)	45.9	52.7
75% Prime Power(1)	34.2	38.9
50% Prime Power(1)	23.1	26.3
25% Prime Power(1)	12.5	14.6

DIMENSION	OPEN	SILENT
Length (A)	2800mm	3450mm
Width (B)	1100mm	1100mm
Height (C)	1650mm	2070mm
Net Weight	2150kg	2750kg

Alternator

Insulation	Clase "H"
Excitation Type	Self-excitation or PMG
Protection class	IP23

Certificates

Engine	ISO 3046, BS 5514, DIN 6271
Alternator	UTE NFC 51-111-105-110 ICE34-1, BS 5000-4999 NEMA MG 21, VDE 0530
Generator Set	ISO 8528

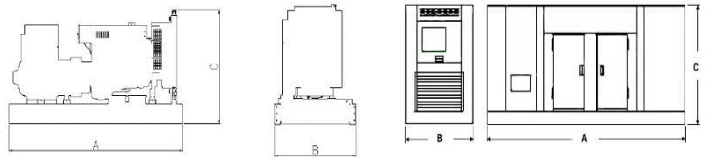

(1) Prime Power: ratings are as per DIN 6271, BS5514 and ISO-3046 with 10% overload capacity

(2) Standby Power: power available at variable load for up to a maximum of 500 hours during one year of which 300 hours may be for continuous use

(3) Operation at Altitude ≤ 1500 m, Ambient temperature $\leq 40^\circ\text{C}$. If altitude higher than 1500m, each 300m will cause additional de-rating 4%.

Certificacion ISO 9001:2000



GENERATOR TYPE ECO 38-1SN/4

Document : DS070A/1

issue 004 date 28/10/2013

Electrical Characteristics										
Frequency	Hz	50				60				
Voltage (series star)	V	380	400	415	440	415	440	460	480	
Rated power class H	kVA	180	180	180	165	210	220	220	220	
	kW	144	144	144	132	168	176	176	176	
Rated power class F	kVA	170	170	170	155	195	205	205	205	
	kW	136	136	136	124	156	164	164	164	
Regulation with DSR		±1 % with any power factor and speed variations between -5% +30%								
Insulation class		H								
Execution		Brushless								
Stator winding		12 ends								
Rotor		with damping cage								
Efficiencies class H	4/4	%	92,3	92,4	92,1	91,9	92,7	93,2	93,3	93,4
(see graph. for details)	3/4	%	92,3	92,6	92,5	92,2	93	93,2	93,4	93,6
	2/4	%	91,2	91,3	91,3	91,1	92	92,1	92,2	92,3
	1/4	%	89,1	88,9	88,7	88,5	90,1	90,1	90,1	89,9
Reactances (f. l.cl. F)	Xd	%	218,3	197	183,0	149,2	251,6	234,4	214,5	197
	Xd'	%	10,7	9,7	9,0	7,3	12,4	11,5	10,6	9,7
	Xd''	%	6,1	5,5	5,1	4,2	7,0	6,5	6,0	5,5
	Xq	%	107,4	96,9	90,0	73,4	123,7	115,3	105,5	96,9
	Xq'	%	107,4	96,9	90,0	73,4	123,7	115,3	105,5	96,9
	Xq''	%	21,8	19,7	18,3	14,9	25,2	23,4	21,5	19,7
	X ₂	%	14,2	12,8	11,9	9,7	16,3	15,2	13,9	12,8
	X ₀	%	3,0	2,7	2,5	2,0	3,4	3,2	2,9	2,7
Short Circuit Ratio	Kcc		0,39	0,44	0,60	0,97	0,28	0,35	0,39	0,44
Time Constants	Td'	sec.	0,073							
	Td''	sec.	0,011							
	Tdo'	sec.	0,70							
	Tα	sec.	0,015							
Short Circuit Current Capacity		%	>300				>350			
Excitation at no load	Amp.		0,65	0,7	0,8	1,1	0,35	0,5	0,6	0,65
Excitation at full load	Amp.		2,9	3,1	3,4	3,5	2,5	2,7	2,8	3
Overload (long-term)		%	1 hour in a 6 hours period 110% rated load							
Overload per 20 sec.		%	300							
Stator Winding Resistance (20 °C)		Ω	0,013							
Rotor Winding Resistance (20 °C)		Ω	3,905							
Exciter Resistance (20 °C)		Ω	Rotor : 0,685				Stator : 15,28			
Heat dissipation at f.l.cl.H	W		12013	11844	12352	11634	13230	12841	12639	12437
Telephone Interference			THF < 2%				TIF < 40			
Radio interference			EN61000-6-3, EN61000-6-2. For others standards apply to factory							
Waveform Distors.(THD) at f. load	LL/LN %		2,8 / 2,7							
Waveform Distors.(THD) at no load	LL/LN %		3,1 / 3							
Mechanical characteristics										
Protection			IP 21 (other protection on request)							
DE bearing			6318.2RS							
NDE bearing			6314.2RS							
Weight of wound stator assembly	kg		168							
Weight of wound rotor assembly	kg		103							
Weight of complete generator	kg		510							
Maximun overspeed	rpm		2250							
Unbalanced magnetic pull at f.l.cl.F	kN/mm		4,4							
Cooling air requirement	m ³ /min		32				39			
Inertia Constant (H)	sec.		0,118				0,140			
Noise level at 1m/7m	dB(A)		82 / 69				86 / 73			

All technical data are to be considered as a reference and they can be modified without any notice

This document is a propriety of Mecc Alte S.p.a..All rights reserved.

50 Hz

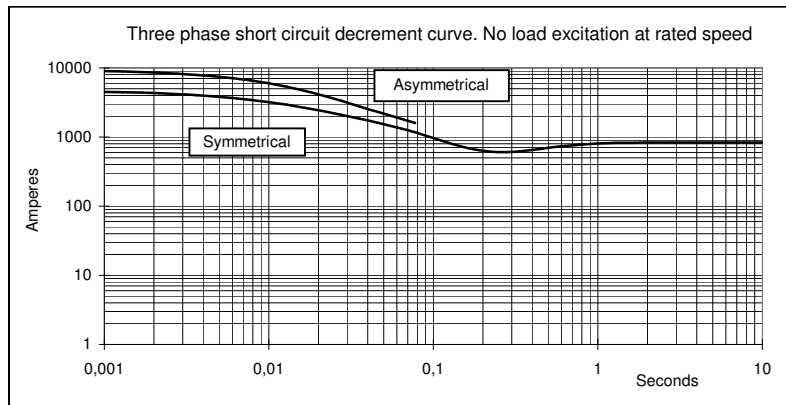
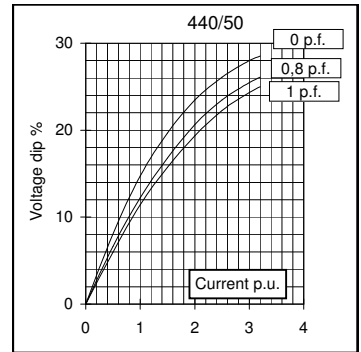
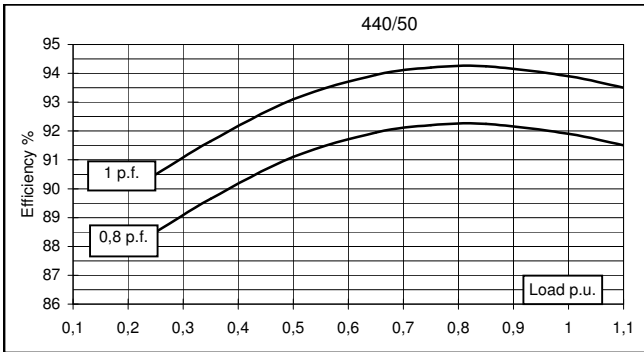
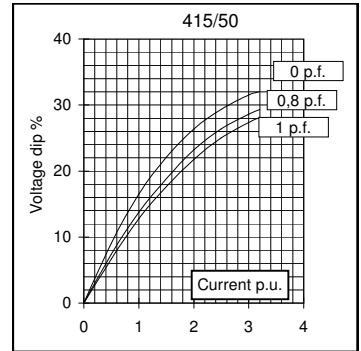
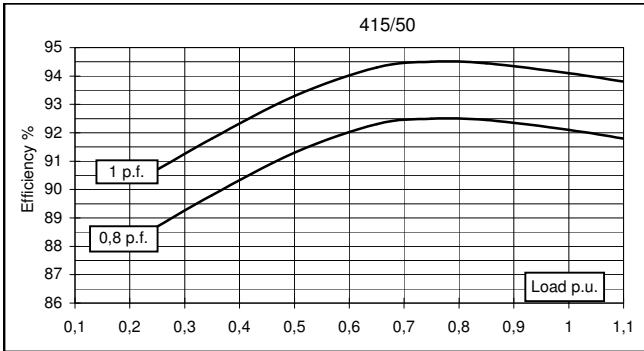
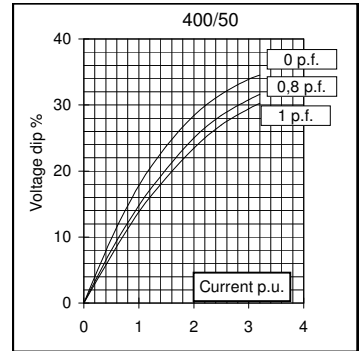
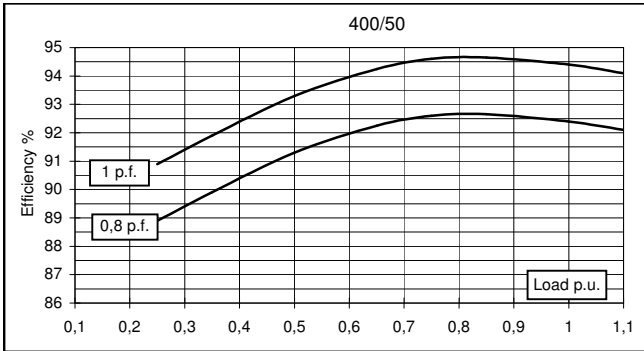
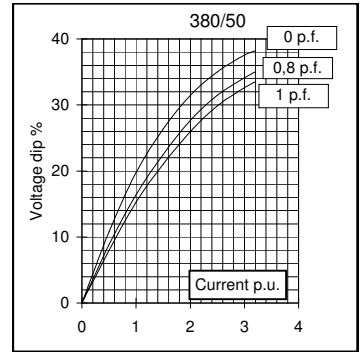
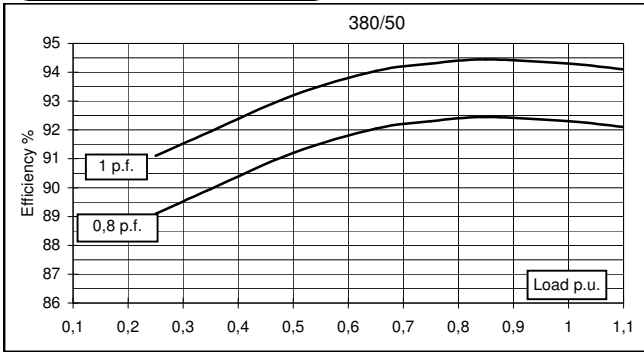



GENERATOR TYPE ECO 38-1SN/4

Document : DS070A/3

issue 004 date : 28/10/2013

60 Hz

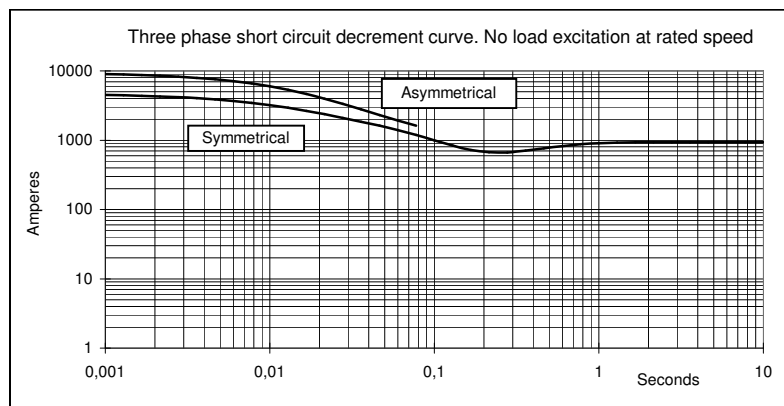
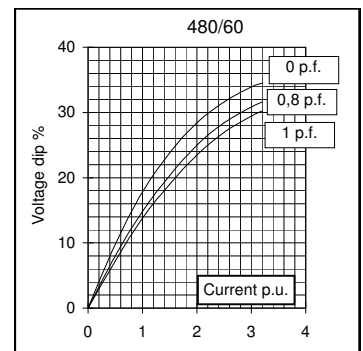
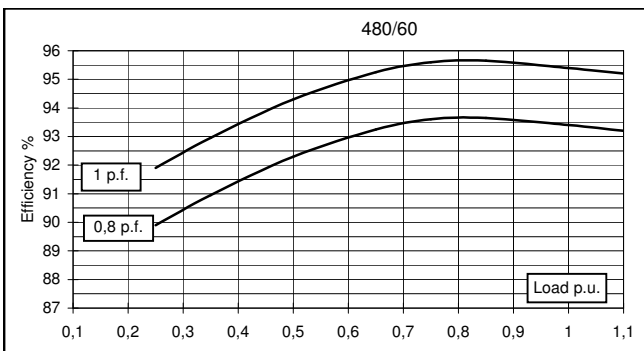
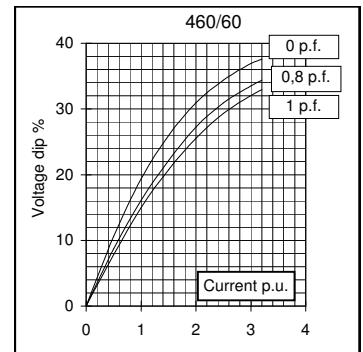
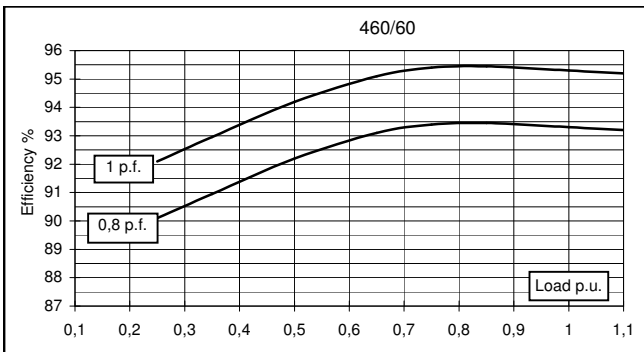
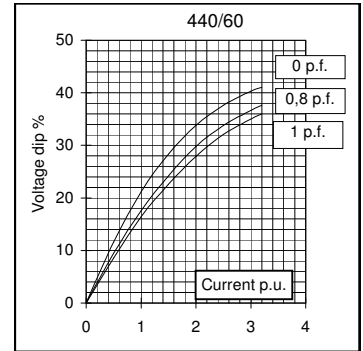
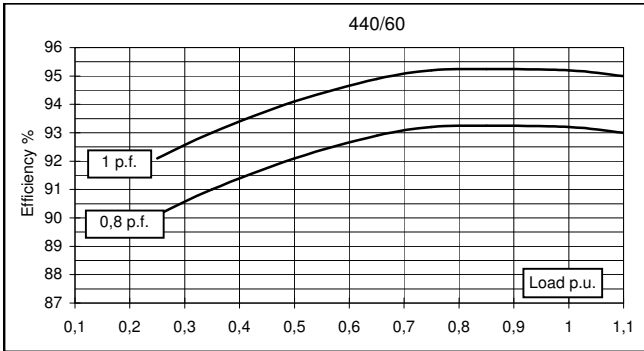
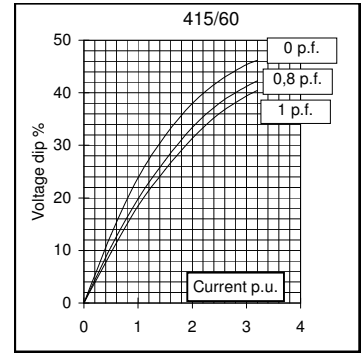
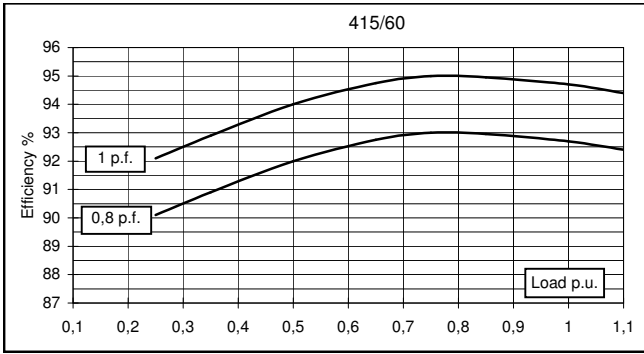

TWO BEARING MOMENTS OF INERTIA

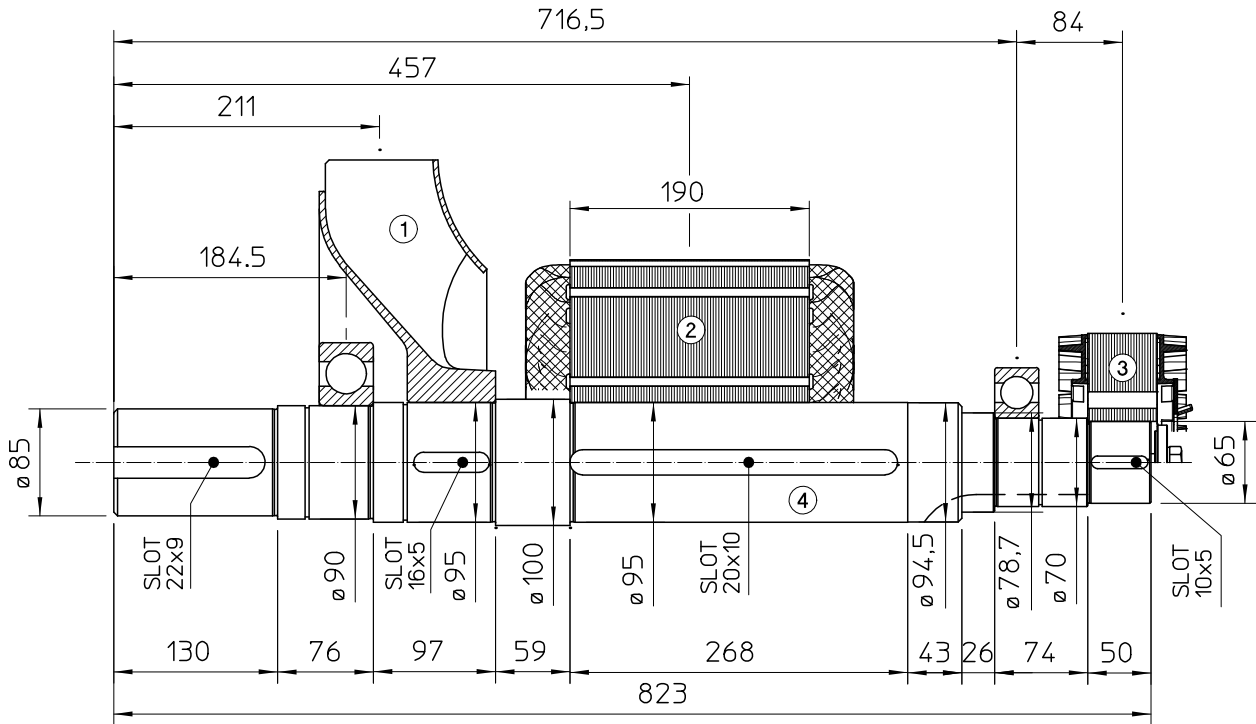

POS.	COMPONENT	WEIGHT (kg)	J (kgm ²)
1	FAN	6.1	0.1887
2	MAIN ROTOR	103	1.4085
3	EX. ROTOR	14.5	0.0874
4	SHAFT	38.5	0.0397
TOTAL		162.1	1.7243

TWO BEARING DIMENSIONS

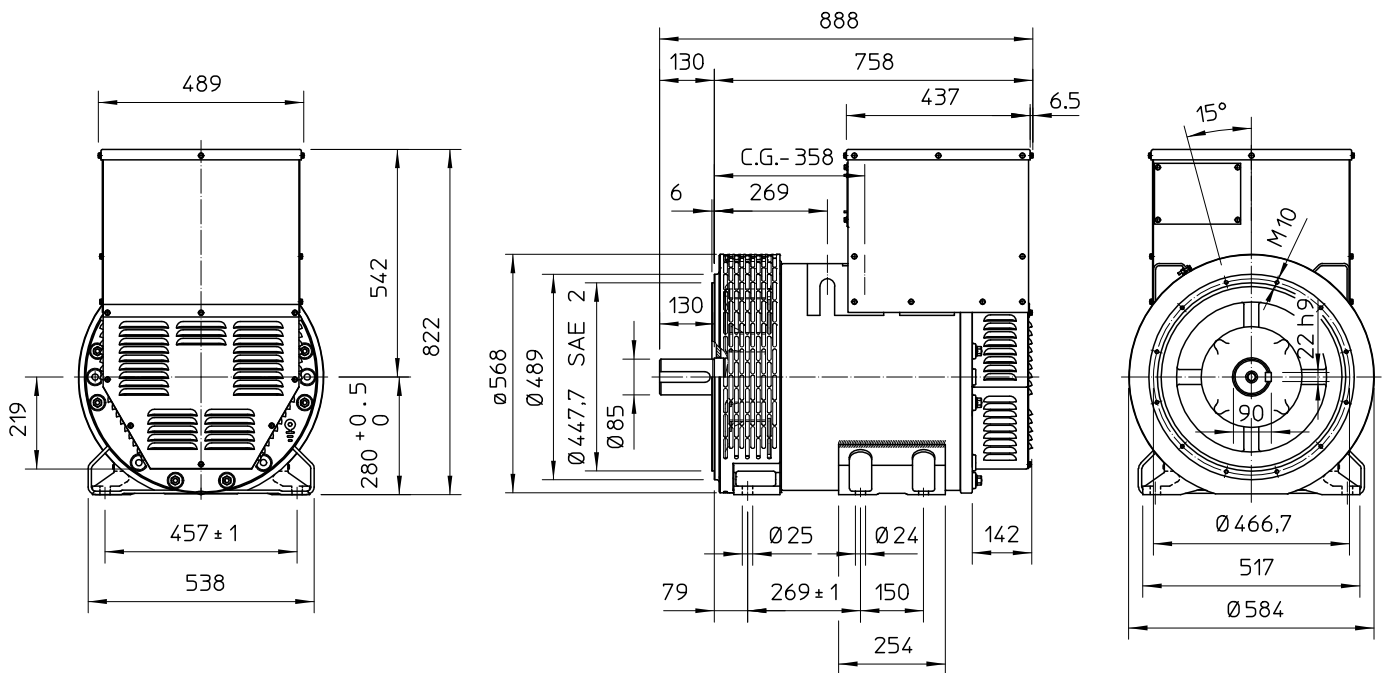

SINGLE BEARING MOMENTS OF INERTIA

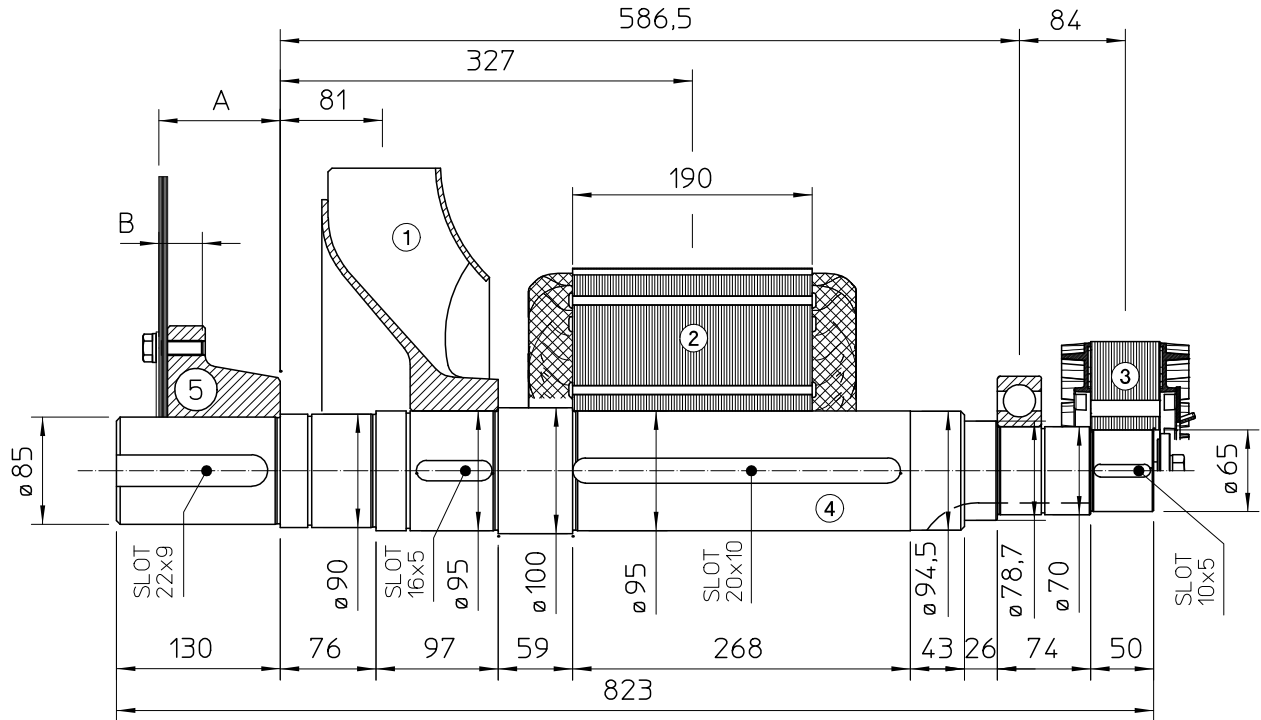

POS.	COMPONENT	WEIGHT (kg)	J (kgm ²)
1	FAN	6.1	0.1887
2	MAIN ROTOR	103	1.4085
3	EX. ROTOR	14.5	0.0874
4	SHAFT	38.5	0.0397
TOTAL		162.1	1.7243

SAE N°	5		SHAFTS COUPLING FLEX PLATE	
	A	B	WEIGHT kg	J kgm ²
11.5	110.4	41.1	20.5	0.174
14	96.4	34.7	23.5	0.275

SINGLE BEARING DIMENSIONS

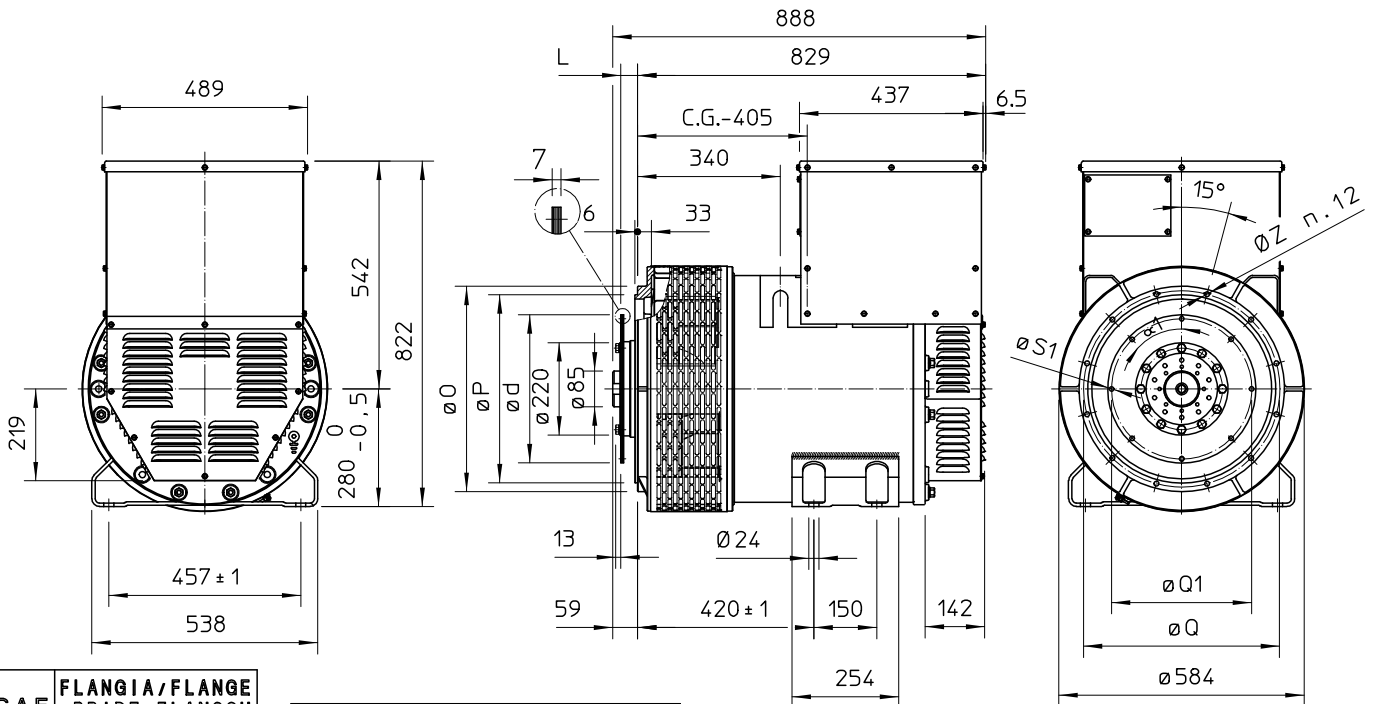

SAE N.	FLANGIA/FLANGE BRIDE/FLANSCH		
	O	P	Q
3	451	409,6	428,6
2	489	447,7	466,7
1	552	511,2	530,2
1/2	648	584,2	619,1

SAE N.	GIUNTI A DISCHI DISC COUPLING DISQUE DE MONOPALIER SCHEIBENKUPPLUNG					
	L	d	Q1	n _{fori}	S1	α1
11 1/2	39,6	352,42	333,37	8	11	45°
14	25,4	466,72	438,15	8	14	45°

C.G.= GRAVITY CENTER