

# KTA50-G3

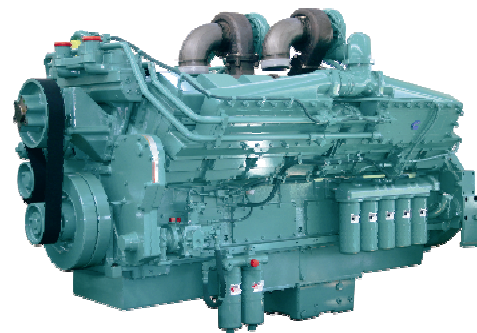

## > Specification sheet



Our energy working for you.™

### Description

The KTA50-Series benefits from years of technical development and improvement to bring customers an innovative and future proof diesel engine that keeps pace with ever changing generator set requirements.

Recognised globally for its performance under even the most severe climatic conditions, the KTA50-Series is widely acknowledged as the most robust and cost-effective diesel engine in its power range for the generator set market.



This engine has been built to comply with CE certification.



This engine has been designed in facilities certified to ISO9001 and manufactured in facilities certified to ISO9001 or ISO9002.

### Features

**Coolpac Integrated Design** - Products are supplied complete with cooling package and air cleaner kit for a complete power package. Each component has been specifically developed and rigorously tested for G-Drive products, ensuring high performance, durability and reliability.

**Aftercooler** – Large capacity aftercoolers result in cooler, denser intake air for more efficient combustion and reduced internal stresses for longer life.

**Cooling System** – Gear driven centrifugal water pump. Large volume water passages provide even flow of coolant around cylinder liners, valves and injectors.

**Pistons** – Aluminium alloy, cam ground and barrel shaped to compensate for thermal expansion assures precise fit at operating temperatures. Grooved skirt finish provides superior lubrication. Oil cooled for rapid heat dissipation.

**Service and Support** - G-Drive products are backed by an uncompromising level of technical support and after sales service, delivered through a world class service network.

### 1500 rpm (50 Hz Ratings)

Gross Engine Output			Net Engine Output			Typical Generator Set Output					
Standby	Prime	Base	Standby	Prime	Base	Standby (ESP)		Prime (PRP)		Base (COP)	
kWm/BHP			kWm/BHP			kWe	kVA	kWe	kVA	kWe	kVA
1227/1645	1097/1470	900/1206	1192/1598	1074/1440	877/1176	1120	1400	1020	1275	842	1052

### 1800 rpm (60 Hz Ratings)

Gross Engine Output			Net Engine Output			Typical Generator Set Output					
Standby	Prime	Base	Standby	Prime	Base	Standby (ESP)		Prime (PRP)		Base (COP)	
kWm/BHP			kWm/BHP			kWe	kVA	kWe	kVA	kWe	kVA
1380/1850	1220/1635	1000/1340	1328/1781	1182/1585	962/1290	1250	1610	1135	1418	924	1154

Our energy working for you.™

[www.cumminsgdrive.com](http://www.cumminsgdrive.com)

©2009 | Cummins G-Drive Engines | Specifications Subject to Change Without Notice | Cummins is a registered trademark of Cummins Inc. (07/09) (GDSS144)



## General Engine Data

Type	4 cycle, In line, Turbocharged and After-cooled
Bore mm	158.8
Stroke mm	158.8
Displacement Litre	50
Cylinder Block	16-cylinder, direct injection, 4-cycle diesel engine
Battery Charging Alternator	55A
Starting Voltage	24V
Fuel System	Direct injection
Fuel Filter	Dual spin on paper element fuel filters with standard water separator
Lube Oil Filter Type(s)	Spin on full flow filter
Lube Oil Capacity (l)	177
Flywheel Dimensions	SAE 0

## Coolpac Performance Data

Cooling System Design	Jacket Water After Cooled	
Coolant Ratio	50% ethylene glycol; 50% water	
Coolant Capacity (l)	152.0	
Limiting Ambient Temp (°C)**	55.6 (50Hz)	51.0 (60Hz)
Fan Power (kWm)	21.0 (50Hz)	36.0 (60Hz)
Cooling System Air Flow (m <sup>3</sup> /s)**	30.3 (50Hz)	34.6 (60Hz)
Air Cleaner Type	Dry replaceable element with restriction indicator	

\*\* @ 13 mm H<sub>2</sub>O

## Ratings Definitions

### Emergency Standby Power (ESP):

Applicable for supplying power to varying electrical load for the duration of power interruption of a reliable utility source. Emergency Standby Power (ESP) is in accordance with ISO 8528. Fuel Stop power in accordance with ISO 3046, AS 2789, DIN 6271 and BS 5514.

### Limited-Time Running Power (LTP):

Applicable for supplying power to a constant electrical load for limited hours. Limited-Time Running Power (LTP) is in accordance with ISO 8528.

### Prime Power (PRP):

Applicable for supplying power to varying electrical load for unlimited hours. Prime Power (PRP) is in accordance with ISO 8528. Ten percent overload capability is available in accordance with ISO 3046, AS 2789, DIN 6271 and BS 5514.

### Base Load (Continuous) Power (COP):

Applicable for supplying power continuously to a constant electrical load for unlimited hours. Continuous Power (COP) in accordance with ISO 8528, ISO 3046, AS 2789, DIN6271 and BS 5514.

## Weight & Dimensions

Length	Width	Height	Weight (dry)
mm	mm	mm	kg
3275	2000	2200	5900

## Fuel Consumption 1500 rpm (50 Hz)

%	kWm	BHP	L/ph	US gal/ph
<b>Standby Power</b>				
100	1227	1645	293	77.4
<b>Prime Power</b>				
100	1097	1470	261	69.0
75	822	1102	199	52.5
50	548	735	139	36.6
25	275	368	76	20.0
<b>Continuous Power</b>				
100	900	1206	216	57.1

## Fuel Consumption 1800 rpm (60 Hz)

%	kWm	BHP	L/ph	US gal/ph
<b>Standby Power</b>				
100	1380	1850	330	87.3
<b>Prime Power</b>				
100	1220	1635	291	76.9
75	915	1226	222	58.7
50	610	818	157	41.6
25	305	409	89	23.6
<b>Continuous Power</b>				
100	1000	1340	242	63.8

## Cummins G-Drive Engines

### Asia Pacific

10 Toh Guan Road  
#07-01  
TT International Tradepark  
Singapore 608838  
Phone 65 6417 2388  
Fax 65 6417 2399

### Europe, CIS, Middle

**East and Africa**  
Manston Park Columbus Ave  
Manston Ramsgate  
Kent CT12 5BF, UK  
Phone 44 1843 255000  
Fax 44 1843 255902

### Latin America

Rua Jati, 310, Cumbica  
Guarulhos, SP 07180-900  
Brazil  
Phone 55 11 2186 4552  
Fax 55 11 2186 4729

### Mexico

Cummins S. de R.L. de C.V.  
Eje 122 No. 200 Zona Industrial  
San Luis Potosi, S.L.P. 78090  
Mexico  
Phone 52 444 870 6700  
Fax 52 444 870 6811

### North America

1400 73rd Avenue N.E.  
Minneapolis, MN 55432  
USA  
Phone 1 763 574 5000  
USA Toll-free 1 877 769 7669  
Fax 1 763 574 5298

Our energy working for you.™

[www.cumminsgdrive.com](http://www.cumminsgdrive.com)

©2009 | Cummins G-Drive Engines | Specifications Subject to Change Without Notice | Cummins is a registered trademark of Cummins Inc. (07/09) (GDSS144)



**PI734A - Technical Data Sheet**

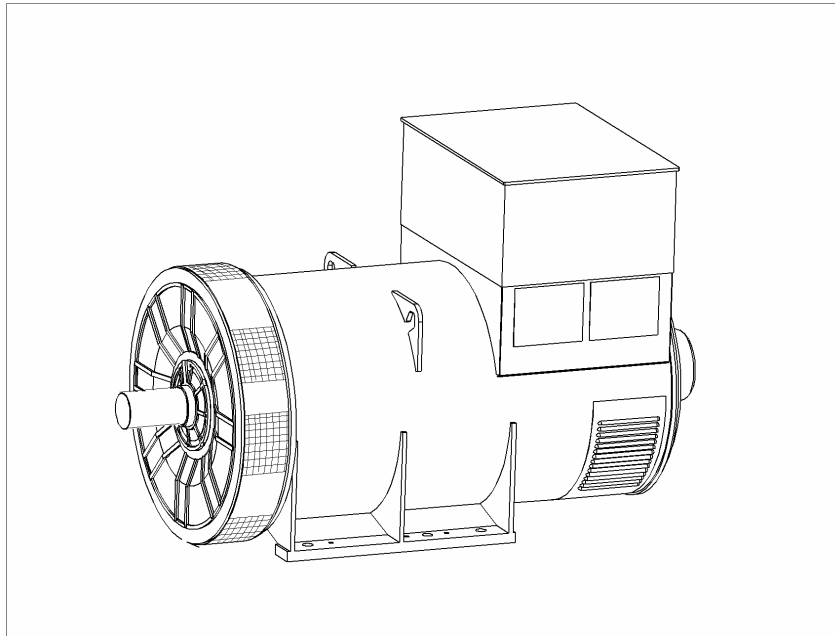

# PI734A

## SPECIFICATIONS & OPTIONS



### STANDARDS

Newage Stamford industrial generators meet the requirements of BS EN 60034 and the relevant sections of other national and international standards such as BS5000, VDE 0530, NEMA MG1-32, IEC60034, CSA C22.2-100, AS1359.

Other standards and certifications can be considered on request.

### DESCRIPTION

The STAMFORD PI range of synchronous ac generators are brushless with a rotating field. They are separately excited by the STAMFORD Permanent Magnet Generator (PMG). This is a shaft mounted, high frequency, pilot exciter which provides a constant supply of clean power via the Automatic Voltage Regulator (AVR) to the main exciter. The main exciter output is fed to the main rotor, through a full wave bridge rectifier, protected by surge suppression.

### VOLTAGE REGULATORS

The PI range generators complete with a PMG are available with one of two AVRs. Each AVR has soft start voltage build up and built in protection against sustained over-excitation, which will de-excite the generator after a minimum of 8 seconds.

Underspeed protection (UFRO) is also provided on both AVRs. The UFRO will reduce the generator output voltage proportional to the speed of the generator below a pre-settable level.

The **MX341 AVR** is two phase sensed with a voltage regulation of  $\pm 1\%$ . (see the note on regulation).

The **MX321 AVR** is 3 phase rms sensed with a voltage regulation of 0.5% rms (see the note on regulation). The UFRO circuit has adjustable slope and dwell for controlled recovery from step loads. An over voltage protection circuit will shutdown the output device of the AVR, it can also trip an optional excitation circuit breaker if required. As an option, short circuit current limiting is available with the addition of current transformers.

Both the MX341 and the MX321 need a generator mounted current transformer to provide quadrature droop characteristics for load sharing during parallel operation. Provision is also made for the connection of the STAMFORD power factor controller, for embedded applications, and a remote voltage trimmer.

### WINDINGS & ELECTRICAL PERFORMANCE

All generator stators are wound to 2/3 pitch. This eliminates triplen (3rd, 9th, 15th ...) harmonics on the voltage waveform and is found to be the optimum design for trouble-free supply of non-linear loads. The 2/3 pitch design avoids excessive neutral currents sometimes seen with higher winding pitches. A fully connected damper winding reduces oscillations during paralleling. This winding, with the 2/3 pitch and carefully selected pole and tooth designs, ensures very low levels of voltage waveform distortion.

### TERMINALS & TERMINAL BOX

Standard generators feature a main stator with 6 ends brought out to the terminals, which are mounted on the frame at the non-drive end of the generator. A sheet metal terminal box contains the AVR and provides ample space for the customers' wiring and gland arrangements. It has removable panels for easy access.

### SHAFT & KEYS

All generator rotors are dynamically balanced to better than BS6861:Part 1 Grade 2.5 for minimum vibration in operation. Two bearing generators are balanced with a half key.

### INSULATION/IMPREGNATION

The insulation system is class 'H', and meets the requirements of UL1446.

All wound components are impregnated with materials and processes designed specifically to provide the high build required for static windings and the high mechanical strength required for rotating components.

### QUALITY ASSURANCE

Generators are manufactured using production procedures having a quality assurance level to BS EN ISO 9001.

### NOTE ON REGULATION

The stated voltage regulation may not be maintained in the presence of certain radio transmitted signals. Any change in performance will fall within the limits of Criteria 'B' of EN 61000-6-2:2001. At no time will the steady-state voltage regulation exceed 2%.

NB Continuous development of our products entitles us to change specification details without notice, therefore they must not be regarded as binding.

Front cover drawing is typical of the product range.

**PI734A**  
**WINDING 312**

CONTROL SYSTEM	SEPARATELY EXCITED BY P.M.G.		
A.V.R.	MX341	MX321	
VOLTAGE REGULATION	± 1%	± 0.5 %	With 4% ENGINE GOVERNING
SUSTAINED SHORT CIRCUIT	REFER TO SHORT CIRCUIT DECREMENT CURVES (page 7)		

INSULATION SYSTEM	CLASS H							
PROTECTION	IP23							
RATED POWER FACTOR	0.8							
STATOR WINDING	DOUBLE LAYER LAP							
WINDING PITCH	TWO THIRDS							
WINDING LEADS	6							
MAIN STATOR RESISTANCE	0.0016 Ohms PER PHASE AT 22°C STAR CONNECTED							
MAIN ROTOR RESISTANCE	1.67 Ohms at 22°C							
EXCITER STATOR RESISTANCE	17.5 Ohms at 22°C							
EXCITER ROTOR RESISTANCE	0.048 Ohms PER PHASE AT 22°C							
R.F.I. SUPPRESSION	BS EN 61000-6-2 & BS EN 61000-6-4,VDE 0875G, VDE 0875N. refer to factory for others							
WAVEFORM DISTORTION	NO LOAD < 1.5% NON-DISTORTING BALANCED LINEAR LOAD < 5.0%							
MAXIMUM OVERSPEED	2250 Rev/Min							
BEARING DRIVE END	BALL. 6228 C3							
BEARING NON-DRIVE END	BALL. 6319 C3							
	1 BEARING				2 BEARING			
WEIGHT COMP. GENERATOR	2760 kg				2710 kg			
WEIGHT WOUND STATOR	1306 kg				1306 kg			
WEIGHT WOUND ROTOR	1139 kg				1077 kg			
WR <sup>2</sup> INERTIA	32.7498 kgm <sup>2</sup>				31.7489 kgm <sup>2</sup>			
SHIPPING WEIGHTS in a crate	2833kg				2779kg			
PACKING CRATE SIZE	194 x 105 x 154(cm)				194 x 105 x 154(cm)			
	50 Hz				60 Hz			
TELEPHONE INTERFERENCE	THF<2%				TIF<50			
COOLING AIR	2.69 m <sup>3</sup> /sec 5700 cfm				3.45 m <sup>3</sup> /sec 7300 cfm			
VOLTAGE STAR	380/220	400/231	415/240	440/254	416/240	440/254	460/266	480/277
kVA BASE RATING FOR REACTANCE VALUES	1225	1260	1260	1235	1370	1500	1510	1525
X <sub>d</sub> DIR. AXIS SYNCHRONOUS	3.51	3.26	3.02	2.64	4.23	4.14	3.81	3.53
X' <sub>d</sub> DIR. AXIS TRANSIENT	0.21	0.20	0.18	0.16	0.26	0.25	0.23	0.22
X'' <sub>d</sub> DIR. AXIS SUBTRANSIENT	0.16	0.15	0.14	0.12	0.19	0.19	0.17	0.16
X <sub>q</sub> QUAD. AXIS REACTANCE	2.26	2.10	1.95	1.70	2.73	2.67	2.46	2.28
X'' <sub>q</sub> QUAD. AXIS SUBTRANSIENT	0.32	0.29	0.27	0.24	0.38	0.37	0.34	0.32
X <sub>L</sub> LEAKAGE REACTANCE	0.04	0.04	0.03	0.03	0.05	0.05	0.04	0.04
X <sub>2</sub> NEGATIVE SEQUENCE	0.22	0.21	0.19	0.17	0.27	0.26	0.24	0.23
X <sub>0</sub> ZERO SEQUENCE	0.03	0.03	0.02	0.02	0.03	0.03	0.03	0.03
REACTANCES ARE SATURATED				VALUES ARE PER UNIT AT RATING AND VOLTAGE INDICATED				
T' <sub>d</sub> TRANSIENT TIME CONST.	0.13s							
T'' <sub>d</sub> SUB-TRANSTIME CONST.	0.01s							
T' <sub>do</sub> O.C. FIELD TIME CONST.	2.14s							
T <sub>a</sub> ARMATURE TIME CONST.	0.02s							
SHORT CIRCUIT RATIO	1/X <sub>d</sub>							

**50  
Hz**

**PI734A**  
Winding 312



**THREE PHASE EFFICIENCY CURVES**

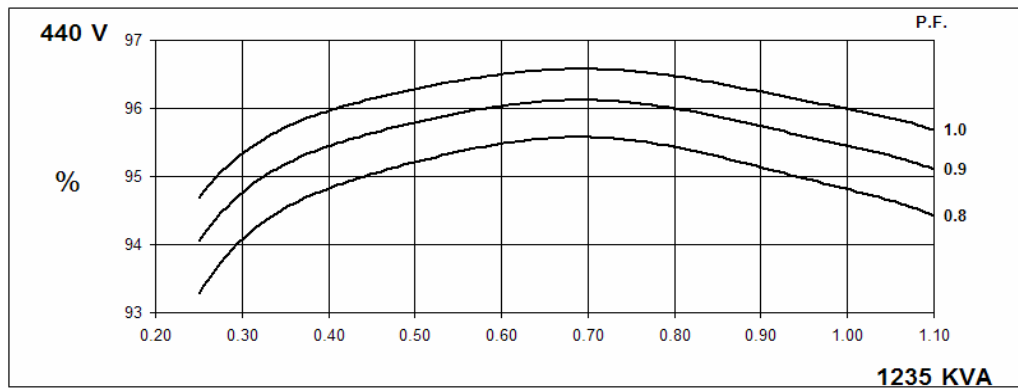
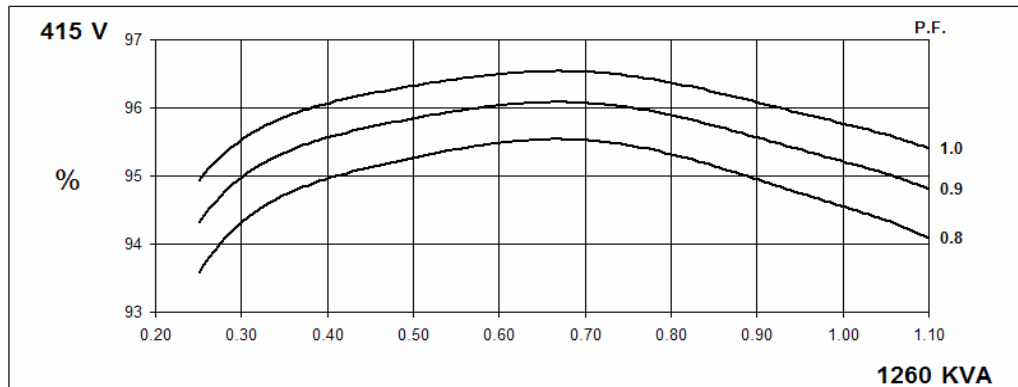
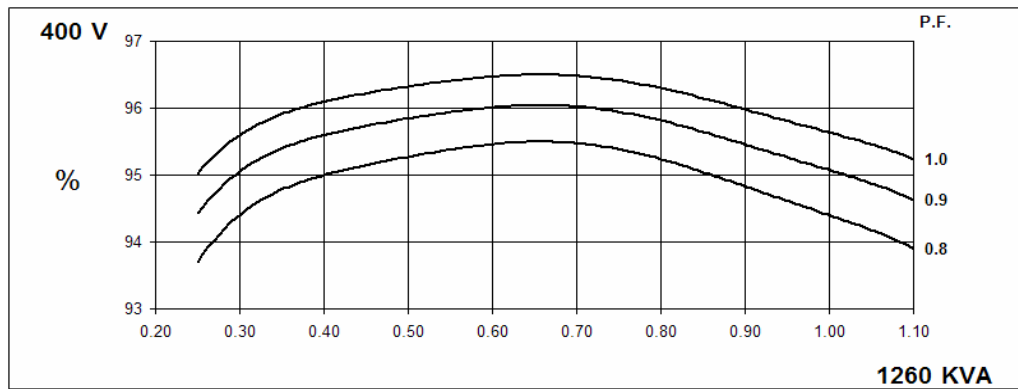
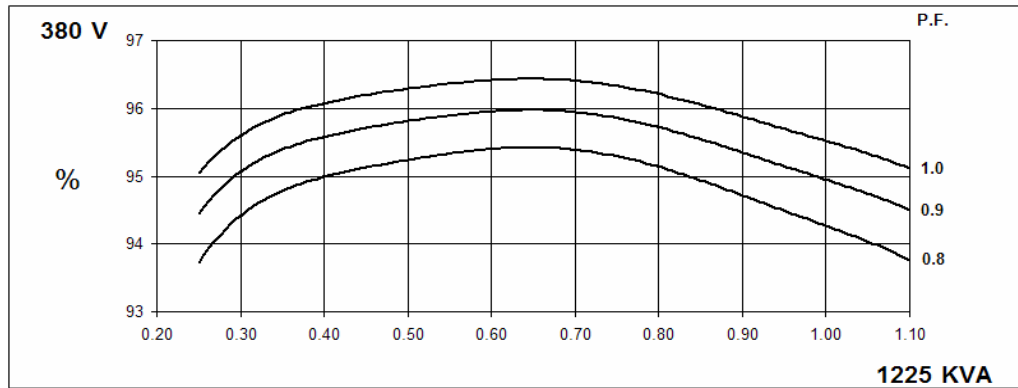

**THREE PHASE EFFICIENCY CURVES**

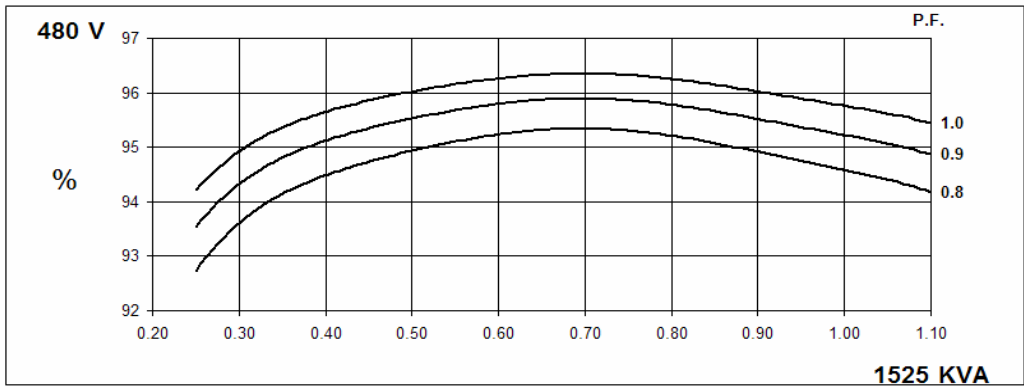
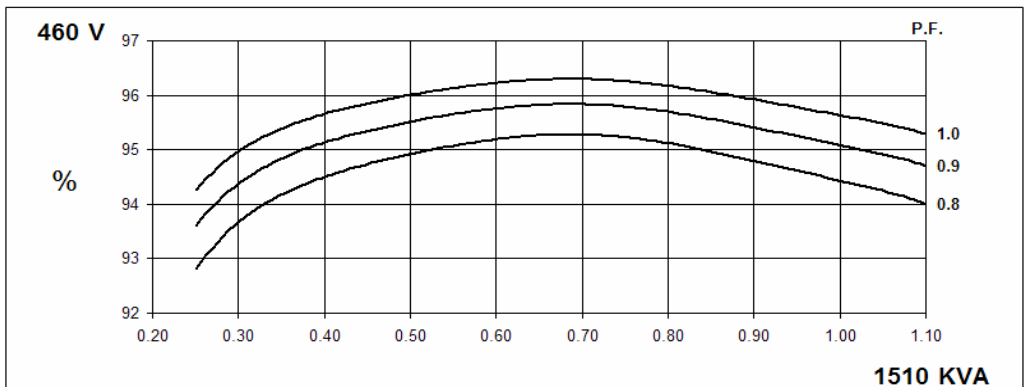
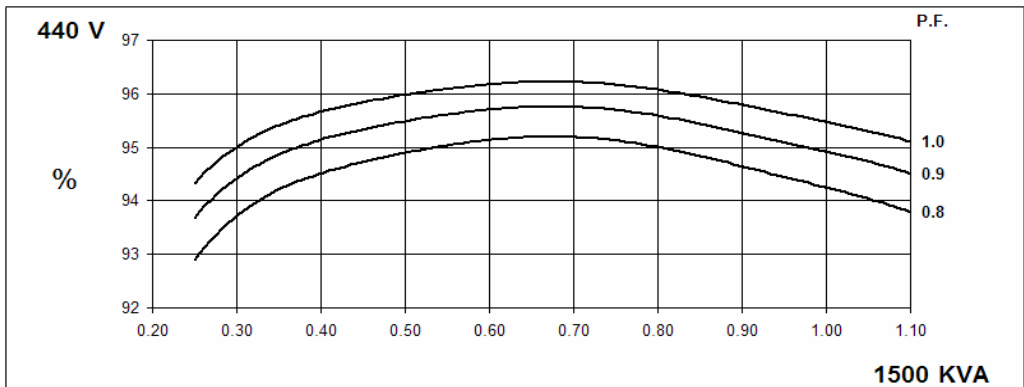
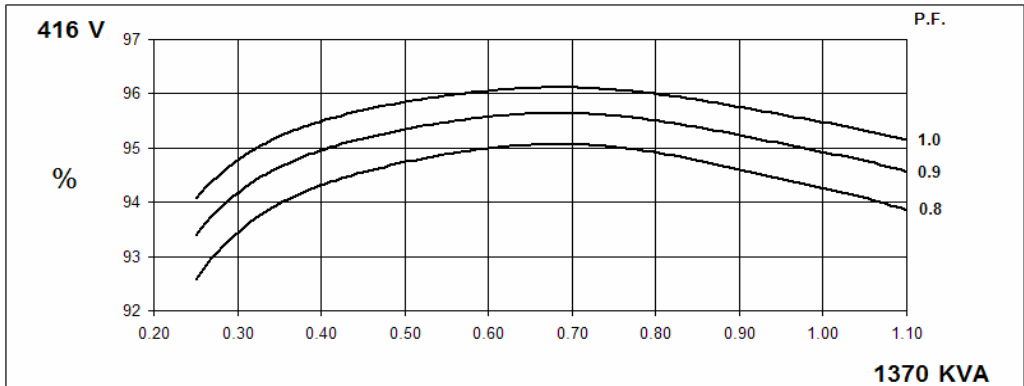

**PI734A**  
Winding 312



**Locked Rotor Motor Starting Curve**

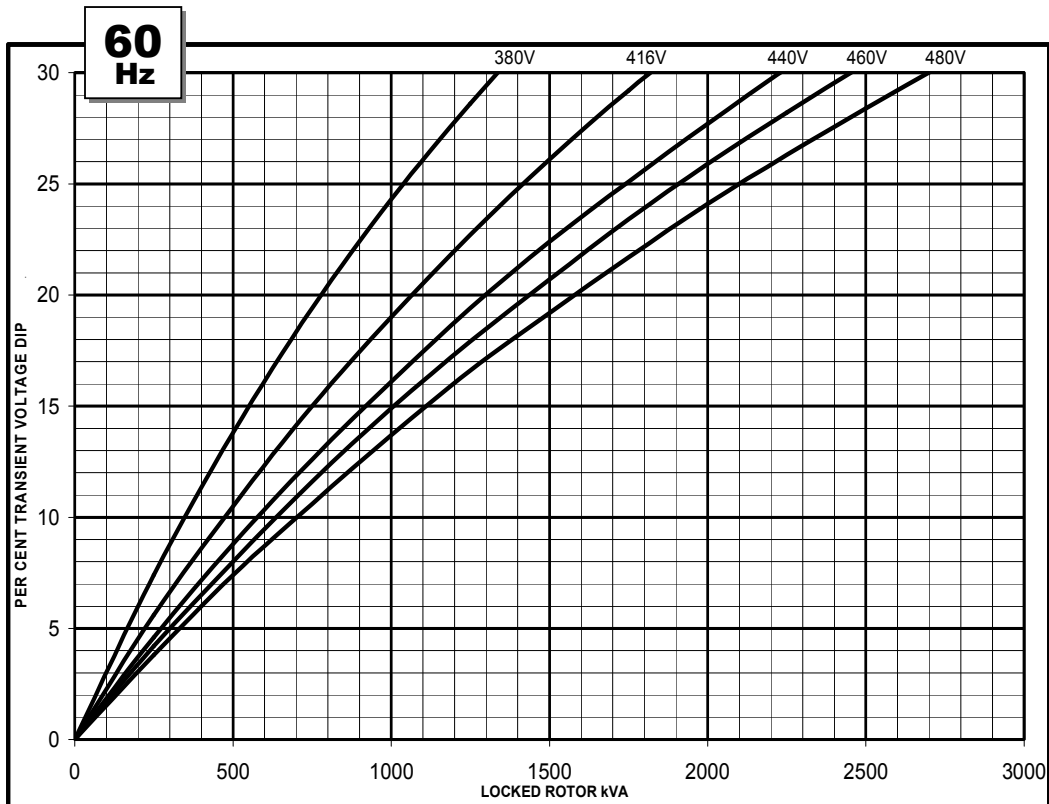



**Three-phase Short Circuit Decrement Curve. No-load Excitation at Rated Speed  
Based on star (wye) connection.**

**50  
Hz**

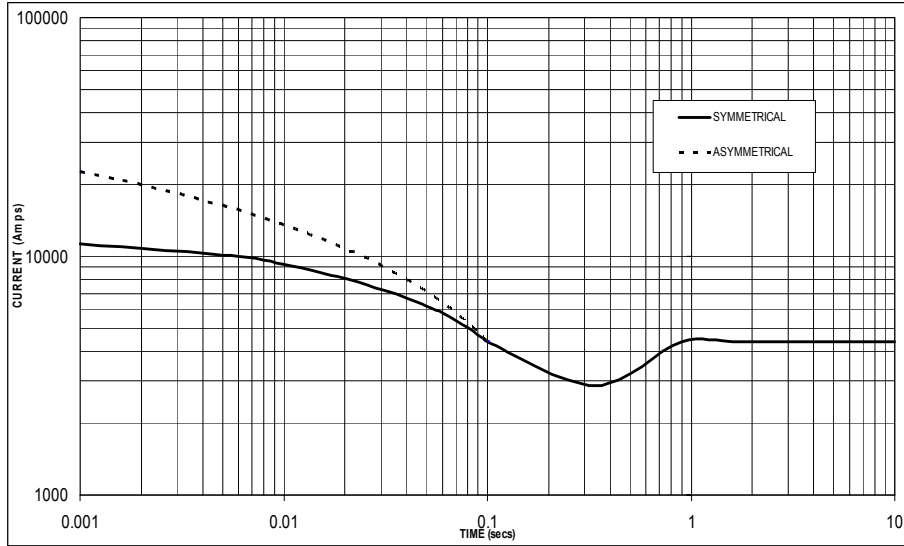

Sustained Short Circuit = 4,400 Amps

**60  
Hz**

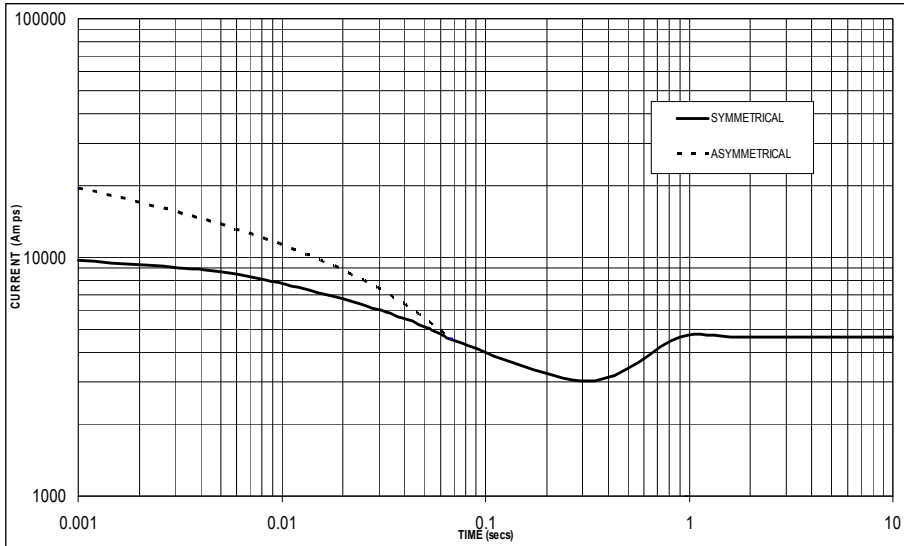

Sustained Short Circuit = 4,650 Amps

**Note 1**

The following multiplication factors should be used to adjust the values from curve between time 0.001 seconds and the minimum current point in respect of nominal operating voltage :

50Hz		60Hz	
Voltage	Factor	Voltage	Factor
380v	x 1.00	416v	x 1.00
400v	x 1.05	440v	x 1.06
415v	x 1.09	460v	x 1.10
440v	x 1.16	480v	x 1.15

The sustained current value is constant irrespective of voltage level

**Note 2**

The following multiplication factor should be used to convert the values calculated in accordance with NOTE 1 to those applicable to the various types of short circuit :

	3-phase	2-phase L-L	1-phase L-N
Instantaneous	x 1.00	x 0.87	x 1.30
Minimum	x 1.00	x 1.80	x 3.20
Sustained	x 1.00	x 1.50	x 2.50
Max. sustained duration	10 sec.	5 sec.	2 sec.

All other times are unchanged

**Note 3**

Curves are drawn for Star (Wye) connected machines.

# PI734A

Winding 312 / 0.8 Power Factor



## RATINGS

Class - Temp Rise		Cont. F - 105/40°C				Cont. H - 125/40°C				Standby - 150/40°C				Standby - 163/27°C			
<b>50Hz</b>	Star (V)	380	400	415	440	380	400	415	440	380	400	415	440	380	400	415	440
	kVA	1140	1175	1175	1150	1225	1260	1260	1235	1275	1315	1315	1290	1310	1350	1350	1325
	kW	912	940	940	920	980	1008	1008	988	1020	1052	1052	1032	1048	1080	1080	1060
	Efficiency (%)	94.5	94.6	94.8	95.0	94.3	94.4	94.6	94.8	94.1	94.2	94.4	94.7	94.0	94.1	94.3	94.6
	kW Input	965	994	992	968	1039	1068	1066	1042	1084	1117	1114	1090	1115	1148	1145	1121

<b>60Hz</b>	Star (V)	416	440	460	480	416	440	460	480	416	440	460	480	416	440	460	480
	kVA	1275	1395	1405	1415	1370	1500	1510	1525	1425	1560	1570	1585	1465	1605	1615	1630
	kW	1020	1116	1124	1132	1096	1200	1208	1220	1140	1248	1256	1268	1172	1284	1292	1304
	Efficiency (%)	94.5	94.5	94.6	94.8	94.3	94.2	94.4	94.6	94.1	94.1	94.3	94.5	94.0	94.0	94.2	94.4
	kW Input	1079	1181	1188	1194	1162	1274	1280	1290	1211	1326	1332	1342	1247	1366	1372	1381

## DIMENSIONS

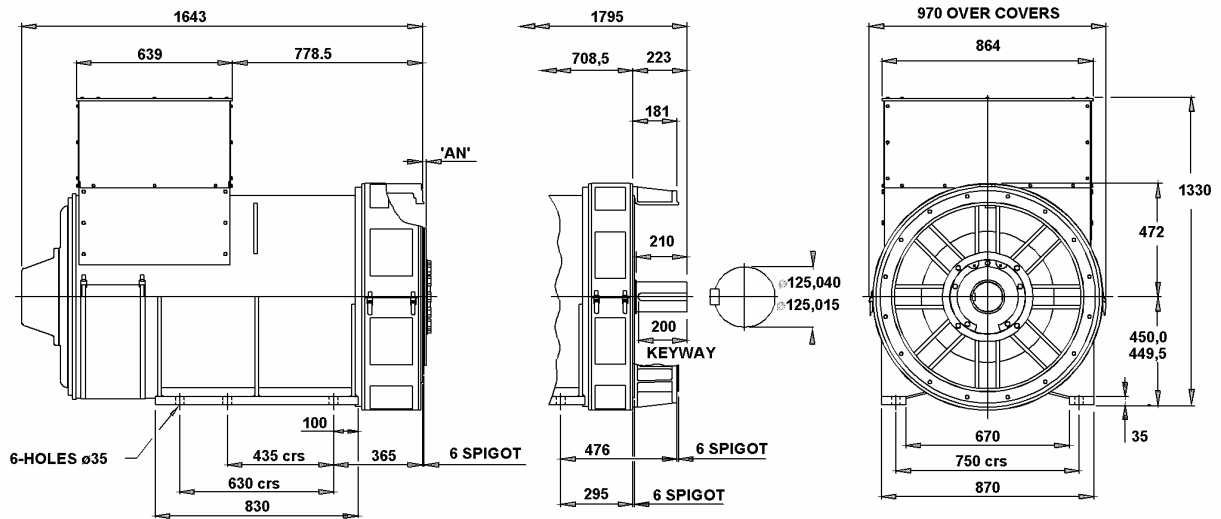

COUPLING DISC	'AN'
S.A.E No 18	15,7
S.A.E No 21	0
S.A.E No 24	0

1-BRG ADAPTORS
S.A.E No 0
S.A.E No 00

2-BRG ADAPTORS
S.A.E No 0
S.A.E No 00



Barnack Road • Stamford • Lincolnshire • PE9 2NB  
 Tel: 00 44 (0)1780 484000 • Fax: 00 44 (0)1780 484100  
 Website: [www.newage-avkseg.com](http://www.newage-avkseg.com)