



Product Catalogue

3-phase Induction Motors

IE1



Certificates

Cantoni Motor SA
ISO 9001
Since September 30, 1999



Besel SA
ISO 9001
Since July 21, 1995

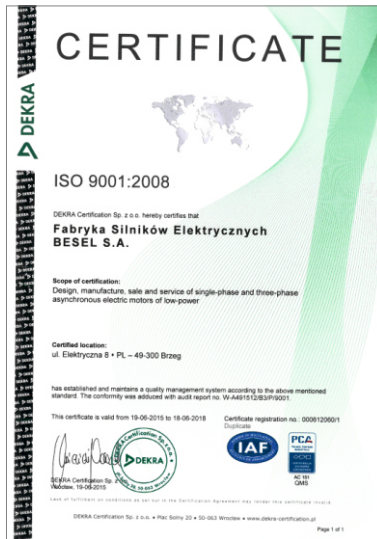

Celma Indukta SA
ISO 9001
Since April 1, 1993



ISO 14001
Since November 15, 1999

Emit SA
ISO 9001:2008
ISO 14001:2004
Since January 23, 2012

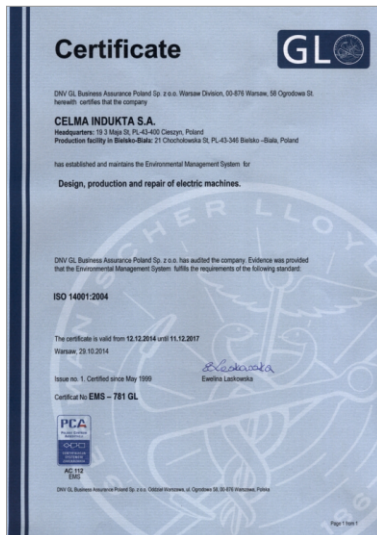



since 1948

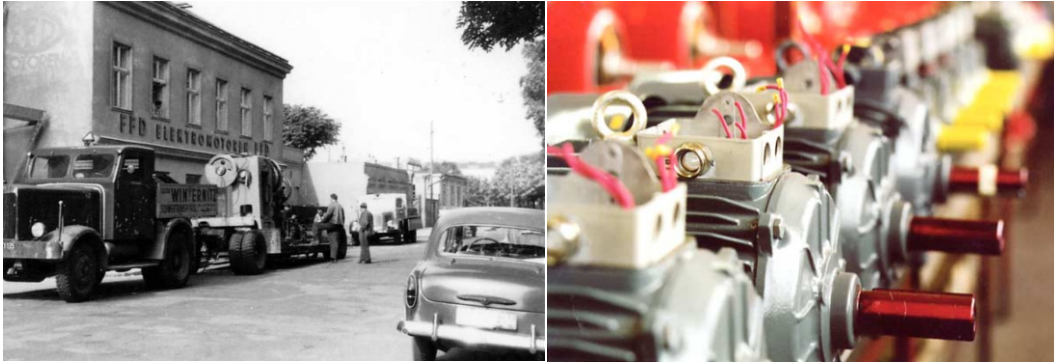

Product range beginning from 0,04kW up to 5000kW

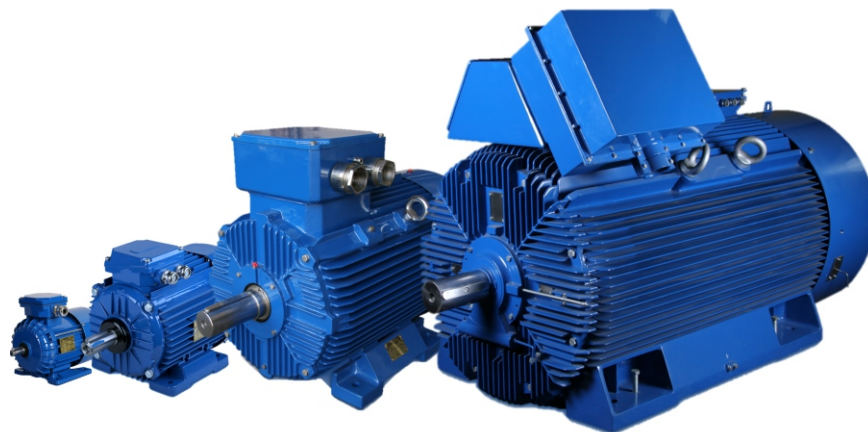

„FFD part of Cantoni Goup” in numbers

- ~ 1900 employees
- Annual production ~ 1.000.000 motors
- Covered area ~ 120.000 m²

OUR SOLUTION FOR YOUR POWER!

Contents

General information

pages 5-12

Ratings - Tolerances , Standards

Insulation classification

Terminal box

Vibration and noise level

Degree of protection

Mounting arrangements

Bearings

Permissible loads on the shaft end

Housing, endshields

Description of the customised executions

Ordering information

Technical data

2 pole motors

page 13

4 pole motors

page 14

6 pole motors

page 15

8 pole motors

page 16

10+12 pole motors

page 17

Dimensional drawings

pages 18-25

List of motor parts

pages 26-28

Notice

pages 29

Production program

pages 30-31

RATINGS - TOLERANCES

Permissible deviations between real values and catalogue values according to the IEC 60034-1:

Power factor $\cos \varphi$	$\Delta \cos \varphi = -1/6 (1 - \cos \varphi_N)$
Efficiency η	$\Delta \eta = -15\% (100 - \eta_N)$ for $P_N \leq 150 \text{ kW}$ $\Delta \eta = -10\% (100 - \eta_N)$ for $P_N > 150 \text{ kW}$
Speed n	$\Delta n = \pm 20\% (n_s - n_N)$ for $P_N > 1 \text{ kW}$ $\Delta n = \pm 30\% (n_s - n_N)$ for $P_N \leq 1 \text{ kW}$
Locked rotor current I_L/I_N	$\Delta(I_L/I_N) = +20\% (I_L/I_N)$
Locked rotor torque T_L/T_N	$\min (T_L/T_N) = -15\% (T_L/T_N)$ $\max (T_L/T_N) = +25\% (T_L/T_N)$
Breakdown torque T_B/T_N	$\Delta(T_B/T_N) = -10\% (T_B/T_N)$
Moment of inertia J [kgm ²]	$\Delta J = \pm 10\% J$
Sound pressure level L_{pA} [dB]	$\Delta L_{pA} = +3 \text{ dB /A/}$

STANDARDS

The electric motors are manufactured according to the international standards:

Rating and performance	IEC 60034-1
Methods for determining losses and efficiency	IEC 60034-2-1
Classification of degrees of protection	IEC 60034-5
Methods of cooling	IEC 60034-6
Symbols of construction and mounting arrangements	IEC 60034-7
Terminal markings and direction of rotation	IEC 60034-8
Noise limits	IEC 60034-9
Dimensions and output of electric machines	IEC 60072-1
Vibration limits	IEC 60034-14

All the motors are manufactured according to Quality Assurance System consistent with ISO 9001.

ISO9001

The motors covered by the present catalogue comply with the regulations and standards effective in other countries, consistent with IEC standards.

IEC

INSULATION CLASSIFICATION

The insulation system of an electric motor is determined by a given insulation class on the basis of its thermal resistance. This thermal resistance should be guaranteed by the entire set of electric insulating materials used in the motor insulating system.

Thermal resistance classification is related to the temperature of the hotspot in the insulation occurring during rated operating conditions of the electric motor, allowing for the highest permissible rise in average temperature.

This rise should be selected so that at the highest permissible ambient temperature, the temperature of the hotspot in insulation will not exceed the value assigned to a given thermal resistance class.

Symbols of thermal resistance classes (permissible insulation temperatures at 40°C ambient temperature)

Symbol	Temperature [°C]
A	105
E	120
B	130
F	155
H	180

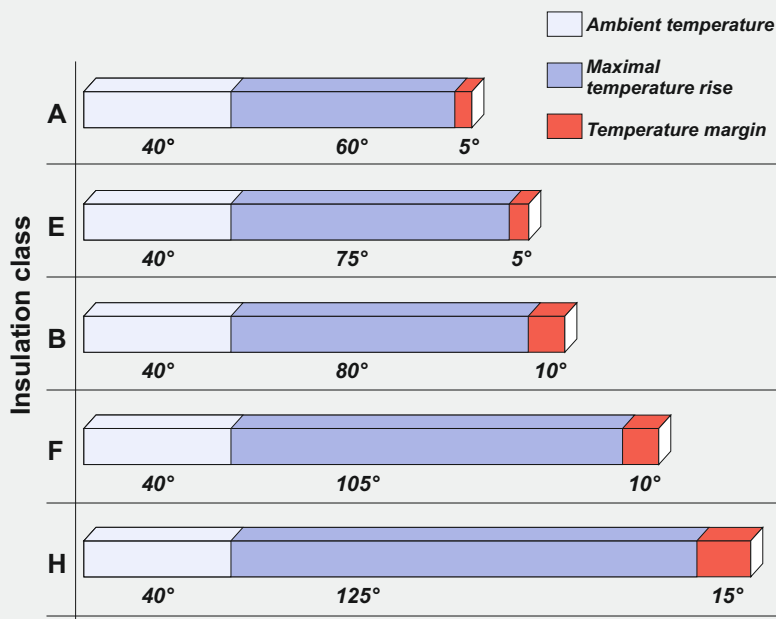

Insulation class F in an electric motor means that at ambient temperature of 40°C the temperature rise of the winding may be max. 105°C with the additional temperature margin of 10°C (under specified measuring conditions in accordance with the IEC 60034-1 standard).

Class F

The standard motors made by FFD in their basic version have the insulation class F. This means longer life for motors.

For special request we can deliver motors equipped with insulation class H.

Strengthened insulation system gives possibility to safe operation with frequency converters.

MOTOR FEET

Motors with frame size ≤ 112 have screwed feet.

Motors with frame size 132 have screwed feet or feet integrated with the motor housing.

Motors with frame size from 160 have feet integrated with the motor housing.

TERMINAL BOX

The terminal boxes of low voltage motors have threaded inlet holes designed for mounting cable glands. The box contains a terminal board with marked terminals making possible connection of supply cables.

In addition, terminal boxes may be provided with additional terminals connected to the ends of thermal protection or anticondensation heater circuits and extra glands to connect these circuits.

Low voltage high-power motors contain terminal boxes with cable gland seals.

The circuits of thermal protection and anticondensation heaters could be connected to separate terminal boxes.

Inside the boxes there are special clamps used to ground the supply cable armouring.

VIBRATION LEVEL AND NOISE LEVEL







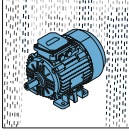
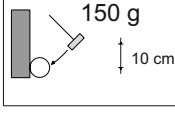

The rotor balancing method guarantees that a standard vibration level A is maintained in accordance with the IEC 60034-14 and a standard sound power level is maintained in accordance with the IEC 60034-9. On customer's demand the motors can be made with reduced vibration or noise level.

level A

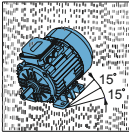
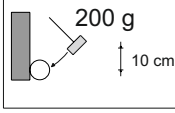
INTERNATIONAL PROTECTION MARKING IP

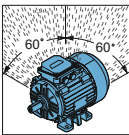
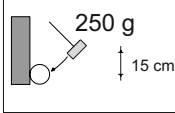
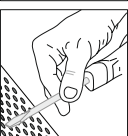
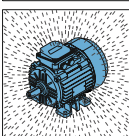
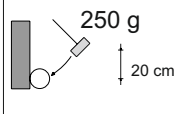
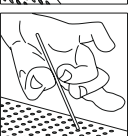
According to the IEC 60034-5 standard the electric motors are provided with IP code which determines the degree of protection (ensured by the housing) against penetration of solid matter and fluids.

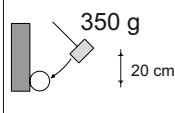
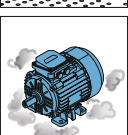
IP55

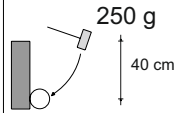
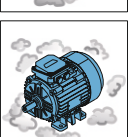
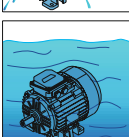
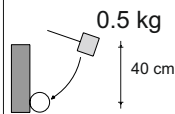
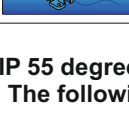
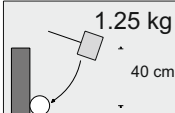
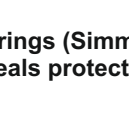
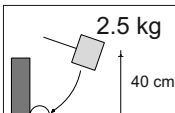
PROTECTION AGAINST PENETRATION OF SOLID MATTER		PROTECTION AGAINST PENETRATION OF FLUIDS		IK	MECHANICAL PROTECTION							
1st digit	DESCRIPTION	2nd digit	DESCRIPTION	3rd digit	DESCRIPTION							
				00	No protection							
0	 Not protected	0	 Not protected	01	 Striking energy: 0.15 J							
	 Protected against solid bodies larger than 50 mm		1		 Protected against vertically falling drops of water	02	 Striking energy: 0.20 J					
	 Protected against solid bodies larger than 12 mm		2		 Protected against vertically falling drops of water up to 15°		03	 Striking energy: 0.37 J				
	 Protected against solid bodies larger than 2.5 mm		3		 Protected against rain up to 60°			04	 Striking energy: 0.50 J			
	 Protected against solid bodies larger than 1 mm		4		 Protected against rain falling from any direction				05	 Striking energy: 0.70 J		
	 Protected against deposition of dust		5		 Protected against sprayed water from any direction					06	 Striking energy: 1 J	
	 Totally protected against deposition of dust		6		 Protected against temporary immersion						07	 Striking energy: 2 J
	7	 Protected against immersion between 0.15 and 1 m	08		 Striking energy: 5 J							
	8	 Protected against immersion at preset pressure and time			09							 Striking energy: 10 J
												10

All FFD standard motors are manufactured with IP 55 degree of protection according to the standard in force (IEC 60034-5). The following table lists its characteristics.



Each size 80 to 180 motor is equipped with seal rings (Simmerring or V-ring) on drive side and on non drive side. Labyrinth seals protect the motors from size 200 and above.

The terminal box is sealed with a gasket.

Motors with a higher degree of protection are available on request.

MOUNTING ARRANGEMENTS

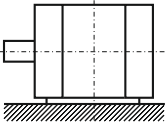
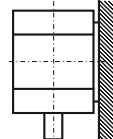
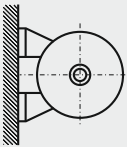
According to the IEC 60034-7 standard

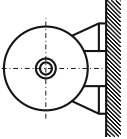
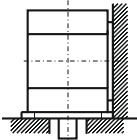
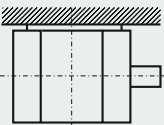
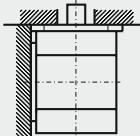
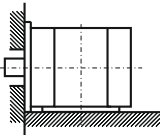
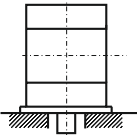
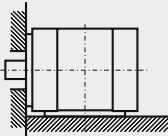
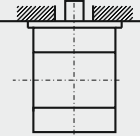
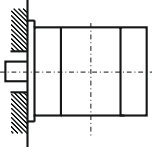
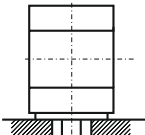
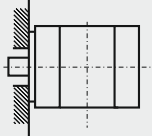
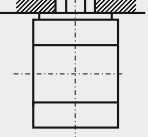
Horizontal shaft				Vertical shaft			
	Designation		Frame size		Designation		Frame size
	Code II	Code I			Code II	Code I	
	IM 1001	IM B3	56 ÷ 500		IM 1011	IM V5	56 ÷ 315 except DFIG 315 M6C except DFIG 315 M8C
	IM 1051	IM B6	56 ÷ 280		IM 1031	IM V6	56 ÷ 315 except DFIG 315 M6C except DFIG 315 M8C
	IM 1061	IM B7	56 ÷ 280		IM 2011 or IM 2111	IM V15	56 ÷ 355 except DFIG 315 M6C except DFIG 315 M8C
	IM 1071	IM B8	56 ÷ 280		IM 2031 or IM 2131	IM V36	56 ÷ 355
	IM 2001	IM B35	56 ÷ 500		IM 3011	IM V1	56 ÷ 500
	IM 2101	IM B34	56 ÷ 132		IM 3031	IM V3	56 ÷ 280
	IM 3001	IM B5	56 ÷ 315 except DFIG 315 M6C except DFIG 315M8C		IM 3611	IM V18	56 ÷ 180
	IM 3601	IM B14	56 ÷ 132		IM 3631	IM V19	56 ÷ 180

* Other mounting arrangements available on special request

PERMISSIBLE LOADS ON THE SHAFT END

Frame size	Number of poles	Horizontal operation		Vertical operation			Frame size	Number of poles	Horizontal operation		Vertical operation		
		$F_R(x=0)$	$F_R(x=\max)$	F_p	F_{a1}	F_{a2}			$F_R(x=0)$	$F_R(x=\max)$	F_p	F_{a1}	F_{a2}
		[kN]		[kN]					[kN]		[kN]		
DPIH 56	2	0,20	0,16	0,04	0,03	0,05	2DPIG 200 LB	6	4,50	3,70	3,70	2,90	4,60
DPIH 56	4	0,25	0,20	0,05	0,04	0,06	2DPIG 200 L	8	5,10	4,20	4,10	3,40	5,00
DPIH 63	2	0,20	0,16	0,04	0,04	0,06	2DPIG 225 S	4	4,50	3,60	3,70	3,00	4,60
DPIH 63	4	0,25	0,20	0,06	0,05	0,07	2DPIG 225 S	8	5,90	4,70	4,70	3,90	5,70
DPIH 63	6	0,27	0,22	0,06	0,05	0,07	2DPIG 225 M	2	3,50	2,90	2,60	2,00	3,40
DPIH 71	2	0,29	0,24	0,07	0,05	0,09	2DPIG 225 M	4	4,30	3,40	3,60	2,80	4,70
DPIH 71	4	0,36	0,30	0,09	0,07	0,11	2DPIG 225 M	6	5,00	4,00	4,10	3,20	5,40
DPIH 71	6	0,40	0,35	0,10	0,08	0,12	2DPIG 225 M	8	5,70	4,60	4,60	3,70	5,80
DPIH 71	8	0,40	0,35	0,11	0,09	0,13	2DPIG 250 M	2	4,30	3,60	3,20	2,40	4,20
DPIH 80	2	0,33	0,27	0,09	0,06	0,12	2DPIG 250 M	4	5,40	4,40	4,40	3,40	5,80
DPIH 80	4	0,44	0,37	0,12	0,09	0,15	2DPIG 250 M	6	6,10	5,00	5,00	3,80	6,70
DPIH 80	6	0,51	0,42	0,14	0,11	0,17	2DPIG 250 M	8	6,90	5,60	5,60	4,30	7,20
DPIH 80	8	0,51	0,42	0,17	0,15	0,20	2DPIG 280 S	2	4,00	3,30	3,10	1,90	4,50
DPIH 90	2	0,58	0,44	0,53	0,30	0,40	2DPIG 280 S	4	6,10	5,10	5,10	3,70	7,00
DPIH 90	4	0,64	0,52	0,60	0,30	0,40	2DPIG 280 S	6	7,50	6,20	6,00	4,70	7,70
DPIH 90	6	0,74	0,68	0,73	0,30	0,40	2DPIG 280 S	8	8,30	6,90	6,60	5,20	8,50
DPIH 90	8	0,82	0,74	0,80	0,30	0,40	2DPIG 280 M	2	3,90	3,20	3,00	1,80	4,60
DPIG 100	2	0,78	0,56	0,70	0,25	0,40	2DPIG 280 M	4	5,90	4,90	5,00	3,50	7,10
DPIG 100	4	0,81	0,79	0,83	0,25	0,40	2DPIG 280 M	6	7,30	6,10	5,90	4,50	7,90
DPIG 100	6	0,98	0,92	0,98	0,25	0,40	2DPIG 280 M	8	8,00	6,60	6,50	4,90	8,60
DPIG 100	8	1,12	1,04	1,11	0,25	0,40	DPIG 315 S	2	3,70	3,20	3,00	1,60	4,80
DPIG 112	2	0,70	0,56	0,67	0,25	0,40	DPIG 315 S	4	6,40	5,30	4,90	3,10	7,30
DPIG 112	4	0,81	0,71	0,79	0,25	0,40	DPIG 315 S	6	7,40	6,20	6,30	4,30	8,90
DPIG 112	6	0,92	0,84	0,92	0,25	0,40	DPIG 315 S	8	8,40	7,00	7,00	5,00	9,60
DPIG 112	8	1,05	0,97	1,05	0,25	0,40	DPIG 315 MA	2	3,60	3,00	2,90	1,50	4,80
2DPIG132	2	1,02	0,94	1,04	0,17	0,57	DPIG 315 MB	2	3,30	2,80	2,90	1,30	4,90
2PIG132	4	1,16	1,04	1,16	0,17	0,57	DPIG 315 MA	4	6,20	5,10	4,80	2,90	7,40
2DPIG132	6	1,40	1,22	1,37	0,17	0,57	DPIG 315 MB	4	5,90	4,90	4,80	2,70	7,50
2DPIG132	8	1,63	1,39	1,57	0,17	0,57	DPIG 315 MA	6	7,20	6,00	6,20	4,10	9,00
DPIG160	2	1,23	1,09	1,22	0,82	1,07	DPIG 315 MB	6	6,80	5,60	6,10	3,60	9,30
DPIG160	4	1,35	1,13	1,32	1,00	1,39	DPIG 315 MA	8	8,20	6,80	6,90	4,80	9,70
DPIG160	6	1,61	1,37	1,58	1,26	1,62	DPIG 315 MB	8	7,70	6,40	6,80	4,30	10,00
DPIG160	8	1,92	1,50	1,80	1,47	1,80							
DPIG180	2	1,90	1,66	1,65	1,00	1,20							
DPIG180	4	2,42	1,82	1,98	1,00	1,35							
DPIG180	6	2,75	2,07	2,15	1,60	1,95							
DPIG180	8	3,30	2,04	2,49	1,90	2,44							
2DPIG200LA	2	3,20	2,60	2,30	1,90	2,90							
2DPIG200LB	2	3,10	2,50	2,30	1,80	2,90							
2DPIG200L	4	3,90	3,20	3,20	2,60	4,00							
2DPIG200LA	6	4,60	3,80	3,70	3,00	4,60							

Value of radial force F_R acting on the shaft end for a given belt pulley diameter is calculated according to the following formula:

$$F_R = \frac{19600 \times P \times k}{D_k \times n} \text{ [N]}$$

where: P - motor output [kW]
 D_k - belt pulley diameter [m]
 n - speed [rpm]
 k - belt tension factor:
 for V-belts $k=2,2$
 for flat belts $k=3$

Value of force F_R acting on any point of the shaft end (between points $X=\max$ and $X=0$) may be calculated according to the following formula:

$$F_R = F_{X0} - \frac{X}{E} \times (F_{X0} - F_{XMAX}) \text{ [N]}$$

where: F_{X0} - value of F_R force acting on the beginning of the shaft end
 F_{XMAX} - value of F_R force acting on the end of the shaft end
 E - length of the shaft end

Other specifications dependent on the frame size:

Frame size	Degree of protection	Position of the terminal box	Number of terminals	Number of cable outlets	Optional rotation of the terminal box	Glands	Temperature sensors in winding	Bearing lubrication system	Thermal protection of bearings
DPIH56	IP 55	top	6	1	180°	M 20	on request	no	no
DPIH63	IP 55	top	6	1	180°	M 20	on request	no	no
DPIH71	IP 55	top	6	1	180°	M 20	on request	no	no
DPIH80	IP 55	top	6	1	180°	M 20	on request	no	no
DPIH90	IP 55	top	6	2	180°	M 20	on request	no	no
DPIG100	IP 55	top	6	2	180°	M 20	on request	no	no
DPIG112	IP 55	top	6	2	180°	M 25	on request	no	no
2DPIG132	IP 55	top	6	2	180°	M 25	on request	no	no
DPIG160	IP 55	top	6	2	180°	M 40	on request	on request	on request
DPIG180	IP 55	top	6	2	180°	M 40	on request	on request	on request
2DPIG200	IP 55	right	6	2+1	4 × 90°	M 50	on request	yes	on request
2DPIG225	IP 55	right	6	2+1	4 × 90°	M 50	on request	yes	on request
2DPIG250	IP 55	right	6	2+1	4 × 90°	M 63	on request	yes	on request
2DPIG280	IP 55	right	6	2+1	4 × 90°	M 63	on request	yes	on request
DPIG315	IP 55	right	6	2+1	4 × 90°	M 76	on request	yes	on request

BEARINGS

Frame size	Number of poles	Bearings
DPIH 56	2 ÷ 6	6201 2Z
DPIH 63	2 ÷ 8	6202 2Z
DPIH 71	2 ÷ 8	6203 2Z
DPIH 80	2 ÷ 8	6204 2Z
DPIH 90	2 ÷ 8	6205 2Z
DPIG 100	2 ÷ 8	6206 2Z
DPIG 112	2 ÷ 8	6306 2Z
2DPIG 132	2 ÷ 8	6308 2Z
DPIG 160	2 ÷ 8	6309 2Z
DPIG 180	2 ÷ 8	6311 2Z
2DPIG 200	2 ÷ 12	6312 C3
2DPIG 225	2 ÷ 12	6313 C3
2DPIG 250	2 ÷ 12	6315 C3
2DPIG 280	2	6315 C3
2DPIG 280	4 ÷ 12	6317 C3
DPIG 315	2	6315 C3
DPIG 315	4 ÷ 12	6318 C3

The bearings in basic version of motors for horizontal duty.

HOUSING, END SHIELDS, FEET

Frame size [mm]	Motor housing	End shields	Feet
56	Aluminium	Aluminium	Aluminium - screwed
63	Aluminium	Aluminium	Aluminium - screwed
71	Aluminium	Aluminium	Aluminium - screwed
80	Aluminium	Aluminium	Aluminium - screwed
90	Aluminium	Aluminium	Aluminium - screwed
100	Aluminium	Aluminium	Aluminium - screwed
112	Aluminium	Cast iron	Aluminium - screwed
132	Cast iron	Cast iron	Cast iron - screwed
160	Cast iron	Cast iron	Cast iron - integrated
180	Cast iron	Cast iron	Cast iron - integrated
200	Cast iron	Cast iron	Cast iron - integrated
225	Cast iron	Cast iron	Cast iron - integrated
250	Cast iron	Cast iron	Cast iron - integrated
280	Cast iron	Cast iron	Cast iron - integrated
315	Cast iron	Cast iron	Cast iron - integrated

In motors of frame size 80, 90 and 100: on request end shields may be made of cast iron.

In motors of frame size 132: feet may be integrated with housing.

Motor housing

aluminium

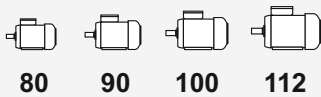

 aluminium  cast iron

cast iron

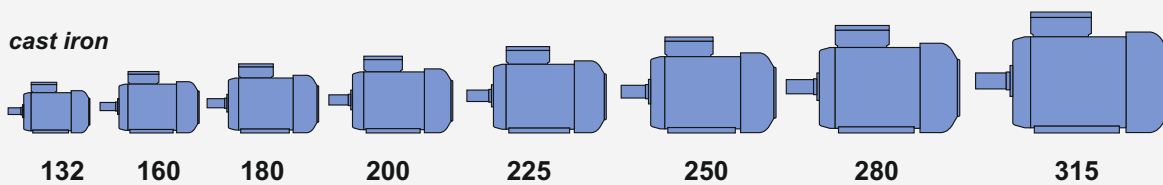

DESCRIPTION OF THE CATALOGUE VERSION

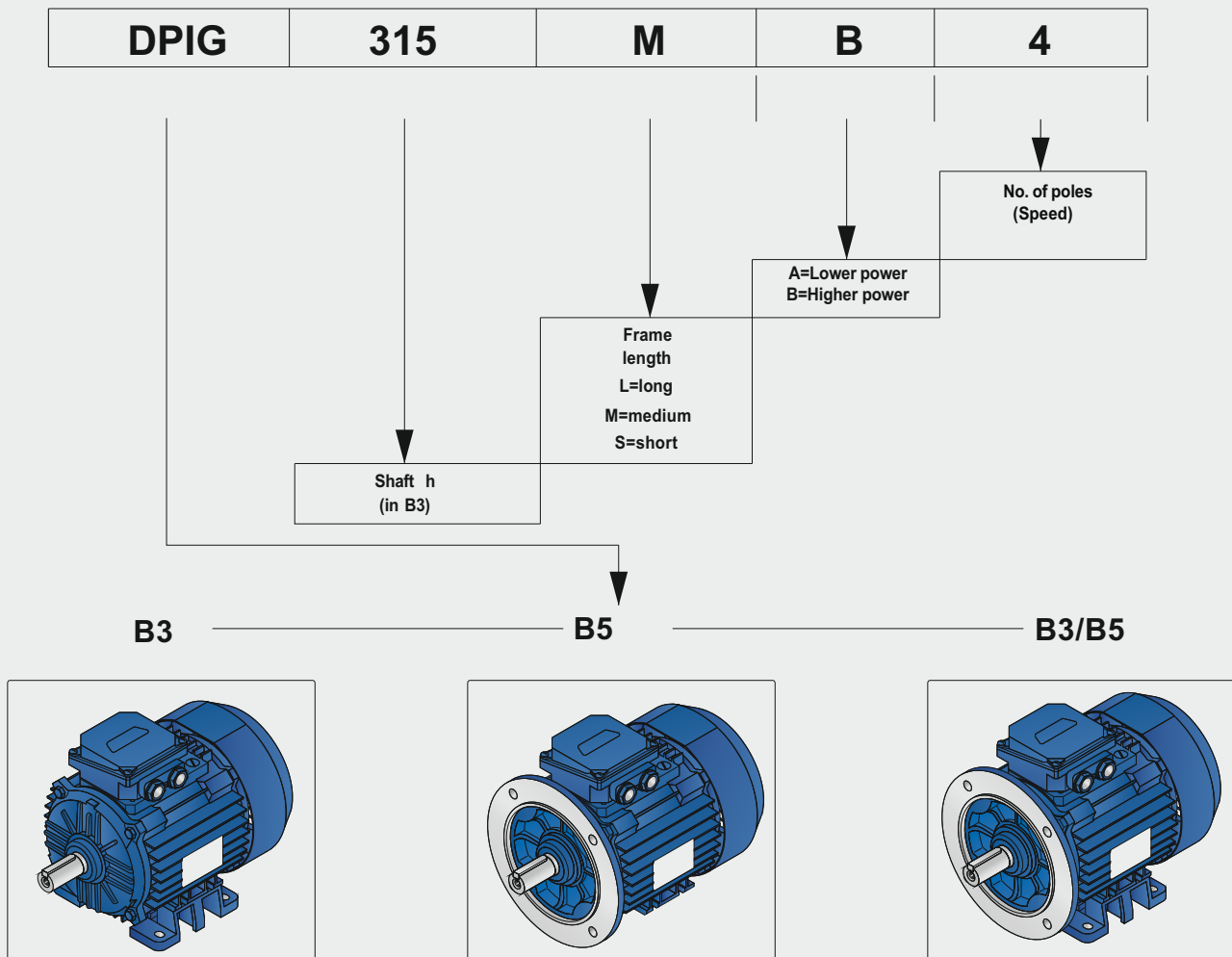

ORDERING INFORMATION

Orders for motors should specify:

- motor type designation,
- rated output,
- rated speed,
- operating duty,
- supply voltage and connection,
- frequency,
- mounting arrangements, end shield material,
- degree of protection,
- type of driven machine,
- other details regarding special requests,

and information concerning additional accessories e.g.

- thermal protection,
- anticondensation heaters,
- vibration sensors,
- etc.

When ordering high-power or special purpose motors one should also indicate:

- required direction of rotation,
- required degree of interior protection,
- method of start-up,
- method of coupling with the driven unit (gears, dimensions of belt pulleys, etc.),
- type of machine driven (nature of load), including the moment of inertia J or flywheel effect GD^2 brought to the motor shaft,
- other customer's specifications.

When ordering spare parts one should specify:

- full designation of the motor type including its serial number (provided on the nameplate) or catalogue number,
- degree of protection,
- mounting arrangement,
- name of part,
- number of pieces.

As part of our development program, we reserve the right to alter or amend any of the specifications without giving prior notice

Totally Enclosed Motors IP 55

Item	Type	Rated output		Rated speed	Rated torque	Efficiency			Power factor	Full load current			Locked rotor torque	Locked rotor current	Breakdown torque	Moment of Inertia	Weight (IMB3)
		P_N				η_N [%] at % of full load	I_N at rated voltage										
		[kW]	[HP]	n_N [min ⁻¹]	T_N [Nm]	50%	75%	100%	cos φ_N [-]	[A] _{230V}	[A] _{380V}	[A] _{400V}	T_L/T_N [-]	I_L/I_N [-]	T_B/T_N [-]	J [kgm ²]	m [kg]
2p=2 n_s=3000 rpm f=50Hz																	
1.	DPIH 56A/2	0,09	0,12	2820	0,30	45	52	62	0,63	0,60	0,35	0,35	2,5	3,4	2,7	0,000076	2,9
2.	DPIH 56B/2	0,12	0,17	2800	0,41	50	58	65	0,70	0,65	0,38	0,38	2,0	3,0	2,0	0,000095	3,2
3.	DPIH 63A/2	0,18	0,25	2760	0,62	63	68	70	0,77	0,85	0,50	0,50	2,1	3,4	2,1	0,000175	3,5
4.	DPIH 63B/2	0,25	0,33	2780	0,85	66	69	72	0,78	1,1	0,65	0,65	2,4	4,0	2,5	0,000235	4,1
5.	DPIH 71A/2	0,37	0,5	2800	1,25	67	69	71	0,77	1,75	1,0	1,0	2,2	4,4	2,2	0,000389	5,0
6.	DPIH 71B/2	0,55	0,75	2790	1,88	69	72	75	0,82	2,35	1,35	1,35	2,0	4,0	2,1	0,000484	6,0
7.	DPIH 80A/2	0,75	1	2800	2,56	66	72	74	0,80	3,3	1,9	1,9	2,7	4,5	2,6	0,000829	7,9
8.	DPIH 80B/2	1,1	1,5	2780	3,78	69	75	77	0,84	4,3	2,5	2,5	2,6	5,1	2,6	0,001005	9,1
9.	DPIH 90S/2	1,5	2,0	2835	5,1	80,7	82,1	81,1	0,83	5,6	3,4	3,2	3,0	6,1	3,0	0,0013	14
10.	DPIH 90L/2	2,2	3,0	2855	7,40	82,2	83,9	83,2	0,82	8,1	4,9	4,7	3,4	7,1	3,5	0,002	16,8
11.	DPIG 100L/2	3,0	4,0	2905	9,9	80,9	83,2	83,4	0,86	10,5	6,4	6,0	2,7	7,5	2,8	0,0048	25
12.	DPIG 112M/2	4	5,5	2865	13,33	85,7	86,4	85,4	0,90	13,1	7,9	7,5	2,1	6,4	2,3	0,0079	34
13.	2DPIG132SA/2	5,5	7,5	2910	18,0	86,4	87,5	87,0	0,88	18,0	10,9	10,4	2,4	7,0	3,2	0,0150	60
14.	2DPIG132SB/2	7,5	10	2920	24,53	88,1	89,2	88,5	0,88	24,2	14,6	13,9	2,5	7,5	3,2	0,0180	71
15.	DPIG 160MA/2	11	15	2945	35,7	88,9	90,1	90,0	0,87	35,3	20,9	20,3	2,2	7,7	3,4	0,042	96
16.	DPIG 160MB/2	15	20	2935	48,8	90,6	91,5	91,0	0,89	46,5	28,1	26,7	2,0	7,2	2,6	0,048	103
17.	DPIG 160L/2	18,5	25	2930	60,3	90,0	90,7	90,3	0,91	56,5	34,2	32,5	2,1	6,8	2,9	0,059	119
18.	DPIG 180M/2	22	30	2920	71,95	89,5	90,8	90,6	0,88	69,3	41,9	39,8	2,5	6,0	2,5	0,076	165
19.	2DPIG200LA/2	30	40	2960	97	92,3	93	92,9	0,89	91	55	52	1,9	6,0	2,3	0,15	245
20.	2DPIG200LB/2	37	50	2960	119	93,4	93,8	93,7	0,89	111	67	64	2,2	6,7	2,5	0,18	265
21.	2DPIG 225M/2	45	60	2968	145	93,8	94,6	94,5	0,89	134	81	77	2,4	7	2,5	0,26	335
22.	2DPIG 250M/2	55	75	2970	177	91,6	93	93,5	0,9	164	99	94	2	6,9	2,4	0,36	410
23.	2DPIG 280S/2	75	100	2977	241	92,5	93,8	94	0,9	223	135	128	2,1	7,5	3,3	0,76	550
24.	2DPIG 280M/2	90	125	2970	289	93	94,2	94,7	0,91	262	159	151	2	7	3,2	0,87	585
25.	DPIG 315S/2	110	150	2977	353	94,3	95,2	95,1	0,91	319	193	183	2,0	8,7	2,8	0,91	690
26.	DPIG 315MA/2	132	175	2975	424	94,5	95,1	95	0,91	383	232	220	2,1	8,5	2,8	0,98	725
27.	DPIG 315MB/2	160	220	2975	514	95,5	95,9	95,4	0,89	473	286	272	2,3	9,1	2,5	1,2	790

Totally Enclosed Motors IP 55

Item	Type	Rated output		Rated speed n_N [min ⁻¹]	Rated torque T_N [Nm]	Efficiency			Power factor $\cos \varphi_N$ [-]	Full load current			Locked rotor torque T_L/T_N [-]	Locked rotor current I_L/I_N [-]	Breakdown torque T_b/T_N [-]	Moment of inertia J [kgm ²]	Weight (IMB3) m [kg]
		P_N	P_N			η_N [%] at % of full load				I_N at rated voltage							
		[kW]	[HP]	[min ⁻¹]	[Nm]	50%	75%	100%	[-]	[A] _{230V}	[A] _{380V}	[A] _{400V}	[-]	[-]	[-]	[kgm ²]	[kg]
2p=4 n_S=1500 rpm f=50Hz																	
28.	DPIH 56A/4	0,06	0,08	1400	0,41	40	48	50	0,58	0,52	0,30	0,30	2,0	2,8	2,3	0,00015	2,6
29.	DPIH 56B/4	0,09	0,12	1400	0,61	54	58	58	0,60	0,70	0,40	0,40	2,1	2,6	2,3	0,00019	2,8
30.	DPIH 63A/4	0,12	0,17	1380	0,83	56	60	60	0,63	0,8	0,45	0,45	1,9	2,6	2,0	0,00024	3,5
31.	DPIH 63B/4	0,18	0,25	1340	1,25	52	55	57	0,66	1,2	0,70	0,70	2,0	2,6	2,0	0,00031	4,1
32.	DPIH 71A/4	0,25	0,33	1380	1,73	60	63	66	0,64	1,5	0,85	0,85	2,0	3,0	2,0	0,00061	5,1
33.	DPIH 71B/4	0,37	0,5	1370	2,60	64	67	70	0,68	2,2	1,25	1,25	2,1	3,1	2,1	0,00077	5,8
34.	DPIH 80A/4	0,55	0,75	1400	3,75	62	68	72	0,71	2,7	1,6	1,7	2,1	3,6	2,1	0,00158	7,5
35.	DPIH 80B/4	0,75	1	1380	5,15	67	73	76	0,70	3,5	2	2	2,4	4	2,3	0,0019	8,8
36.	DPIH 90S/4	1,1	1,5	1405	7,48	75,5	77,8	76,7	0,8	4,5	2,7	2,6	2,2	4,9	2,8	0,0023	14
37.	DPIH 90L/4	1,5	2	1410	10,16	78,1	80	79	0,78	6,1	3,7	3,5	2,5	5,3	2,8	0,0028	16,5
38.	DPIG 100LA/4	2,2	3	1425	14,74	80,2	82,3	82	0,80	8,3	5,1	4,8	2,5	6,1	2,8	0,0058	25
39.	DPIG 100LB/4	3,0	4,0	1415	20,25	81,1	83,1	82,7	0,81	11,2	6,8	6,5	2,6	6,1	2,7	0,0065	26
40.	DPIG 112M/4	4	5,5	1435	26,62	84	85,6	85,1	0,82	14,4	8,7	8,3	2,6	6,3	3	0,0118	34
41.	2DPIG 132S/4	5,5	7,5	1450	36,22	84,3	86,1	85,9	0,84	19,1	11,6	11	2,2	6,9	3,1	0,029	62
42.	2DPIG 132M/4	7,5	10	1450	49,4	87	87,8	87	0,85	25,5	15,4	14,6	2,4	6,7	3,1	0,035	73
43.	DPIG 160M/4	11	15	1460	71,95	88,2	89,3	89	0,85	36,5	22,1	21,0	2,3	7	3,1	0,061	105
44.	DPIG 160L/4	15	20	1460	98	89,1	89,9	89,5	0,87	48,4	29,3	27,8	2,4	7,3	3,2	0,075	125
45.	DPIG 180M/4	18,5	25	1470	120	90	90,9	90,5	0,90	57,0	34,5	32,8	2,4	6,8	2,9	0,135	165
46.	DPIG 180L/4	22	30	1465	143	90,4	91,3	91	0,90	67,4	40,8	38,8	2,7	7,3	2,8	0,155	175
47.	2DPIG 200L/4	30	40	1472	196	92,4	93	92,5	0,88	93	56	53	2,9	7,1	2,5	0,31	265
48.	2DPIG 225S/4	37	50	1475	240	92	93	92,6	0,88	114	69	66	2,1	6,3	2,2	0,44	315
49.	2DPIG 225M/4	45	60	1480	290	93,9	94,3	94	0,88	137	83	79	2,6	7	2,3	0,53	345
50.	2DPIG 250M/4	55	75	1483	354	93,2	93,9	93,5	0,91	162	98	93	2,4	7,3	2,6	0,79	425
51.	2DPIG 280S/4	75	100	1485	482	92,5	93,5	94,2	0,90	222	134	128	2,5	7,3	2,5	1,37	585
52.	2DPIG 280M/4	90	125	1485	579	93,5	94,3	94,8	0,91	262	159	151	2,6	7,3	2,6	1,63	630
53.	DPIG 315S/4	110	150	1480	710	94,1	94,4	94,2	0,92	379	193	183	2,3	6,9	2,2	1,67	720
54.	DPIG 315MA/4	132	175	1487	848	94,5	95	94,9	0,90	388	235	223	2,3	7,6	2,5	1,84	750
55.	DPIG 315MB/4	160	220	1489	1026	94,8	95,4	95,4	0,86	490	296	281	2,7	8,5	2,4	2,24	800

Totally Enclosed Motors IP 55

Item	Type	Rated output		Rated speed	Rated torque	Efficiency			Power factor	Full load current			Locked rotor torque	Locked rotor current	Breakdown torque	Moment of inertia	Weight (IMB3)
		P_N				η_N	T_N	η_N [%] at % of full load			I_N at rated voltage						
		[kW]	[HP]	[min ⁻¹]	[Nm]	50%	75%	100%	[-]	[A] _{230V}	[A] _{380V}	[A] _{400V}	[-]	[-]	[-]	[kgm ²]	[kg]
2p=6 n_s=1000 rpm f=50Hz																	
56.	DPIH 56B/6	0,06	0,08	870	0,64	44	46	50	0,65	1,1	0,65	0,65	1,3	1,8	1,5	0,00019	2,8
57.	DPIH 63A/6	0,09	0,12	820	1,05	26	32	40	0,75	0,8	0,45	0,45	1,15	1,9	1,3	0,00024	3,5
58.	DPIH 63B/6	0,12	0,17	870	1,30	38	44	50	0,65	1,15	0,65	0,65	1,3	1,8	1,1	0,00031	4,1
59.	DPIH 71A/6	0,18	0,25	890	1,93	47	54	57	0,68	1,3	0,75	0,75	1,9	2,6	1,9	0,00074	4,8
60.	DPIH 71B/6	0,25	0,33	860	2,78	45	52	55	0,79	1,75	1,0	1,0	1,6	2,0	1,6	0,00095	5,8
61.	DPIH 80A/6	0,37	0,5	910	3,88	61	63	64	0,65	2,4	1,4	1,4	2,0	3,0	2,1	0,00169	7,4
62.	DPIH 80B/6	0,55	0,75	900	5,84	62	65	67	0,70	3,1	1,8	1,8	1,9	2,7	2,0	0,00207	8,7
63.	DPIH 90S/6	0,75	1	915	7,83	70,2	73,3	72,4	0,72	3,6	2,2	2,1	1,9	3,7	2,2	0,002	13,5
64.	DPIH 90L/6	1,1	1,5	920	11,42	73,5	76,2	75,4	0,71	5,2	3,1	3,0	2,2	4	2,2	0,0028	16,5
65.	DPIG 100L/6	1,5	2	945	15,16	74	76,9	76,7	0,73	6,7	4,1	3,9	1,9	4,6	2,3	0,009	24
66.	DPIG 112M/6	2,2	3	960	21,89	81,6	83,8	83,8	0,78	8,4	5,1	4,9	2,2	5,9	2,8	0,0177	33
67.	2DPIG 132S/6	3	4	950	30,16	79,2	81,5	81	0,78	11,9	7,2	6,9	2,1	5,4	2,8	0,025	54
68.	2DPIG 132MA/6	4	5,5	950	40,21	83,5	84,8	84	0,79	15,1	9,2	8,7	2,4	6	3,1	0,032	66
69.	2DPIG 132MB/6	5,5	7,5	950	55,29	84,8	85,9	85	0,79	20,6	12,4	11,8	2,7	6,3	3,1	0,04	72
70.	DPIG 160M/6	7,5	10	960	74,61	86,6	87,9	87,5	0,81	26,6	16,1	15,3	2,3	6,5	3,1	0,072	100
71.	DPIG 160L/6	11	15	960	109,4	88,3	89,2	88,5	0,82	38	23	21,9	2,4	7	3,1	0,096	125
72.	DPIG 180L/6	15	20	975	146,9	88	89,2	89	0,84	50,4	30,5	29,0	2,8	6	2,4	0,22	170
73.	2DPIG 200LA/6	18,5	25	980	180	90	90,8	90,5	0,86	60	36	34,5	2,5	6,8	2,4	0,41	250
74.	2DPIG 200LB/6	22	30	981	214	90	90,8	90,5	0,88	69	42	40	2,4	6,9	2,2	0,47	265
75.	2DPIG 225M/6	30	40	982	292	92,3	92,5	91,9	0,88	93	56	54	2,1	6,3	2,2	0,76	325
76.	2DPIG 250M/6	37	50	985	359	92	92,8	92,5	0,89	113	68	65	2,6	6,8	2,3	1,23	430
77.	2DPIG 280S/6	45	60	985	436	91,8	93	93	0,87	140	85	80	2	6,5	2,3	1,35	525
78.	2DPIG 280M/6	55	75	985	533	93,2	93,5	93,5	0,89	166	100	95	2,2	6,2	2,2	1,61	565
79.	DPIG 315S/6	75	100	985	727	93,2	93,6	93,5	0,89	226	137	130	2,3	6,6	2,2	2,16	730
80.	DPIG 315MA/6	90	125	984	873	92,8	93,8	93,7	0,88	274	166	158	2,5	6,8	2	2,29	740
81.	DPIG 315MB/6	110	150	985	1066	93	94	94,2	0,89	329	199	189	2,3	7,2	2,1	2,86	840

Totally Enclosed Motors IP 55

Item	Type	Rated output		Rated speed	Rated torque	Efficiency			Power factor	Full load current			Locked rotor torque	Locked rotor current	Breakdown torque	Moment of inertia	Weight (IMB3)
		P_N				η_N [%] at % of full load	I_N at rated voltage										
		[kW]	[HP]	[min ⁻¹]	[Nm]	50%	75%	100%	[-]	[A] _{230V}	[A] _{380V}	[A] _{400V}	T_L/T_N	I_L/I_N	T_b/T_N	J	m
2p=8 n_s=750 rpm f=50Hz																	
82.	DPIH 63A/8	0,04	0,05	670	0,57	20	31	35	0,60	0,6	0,35	0,35	1,6	1,7	1,7	0,00024	3,5
83.	DPIH 63B/8	0,06	0,08	660	0,87	20	24	28	0,48	1,1	0,65	0,65	1,4	1,5	1,6	0,000307	4,1
84.	DPIH 71A/8	0,09	0,12	680	1,26	25	31	35	0,50	1,3	0,75	0,75	1,9	1,9	1,9	0,000736	4,7
85.	DPIH 71B/8	0,12	0,17	670	1,71	40	45	47	0,63	1,25	0,7	0,7	1,7	1,9	1,8	0,000946	5,6
86.	DPIH 80A/8	0,18	0,25	680	2,53	43	51	53	0,57	1,55	0,9	0,9	1,8	2,3	2,0	0,001693	7,2
87.	DPIH 80B/8	0,25	0,33	680	3,51	52	55	57	0,60	2,1	1,2	1,2	1,7	2,5	1,7	0,00207	8,7
88.	DPIH 90S/8	0,37	0,5	695	5,08	54,2	60,8	63,4	0,59	2,5	1,5	1,4	1,7	2,9	2,3	0,0021	13,4
89.	DPIH 90L/8	0,55	0,75	675	7,78	60,4	65,3	65	0,64	3,3	2	1,9	1,7	2,8	1,9	0,0024	15,3
90.	DPIG 100LA/8	0,75	1	710	10,1	65,9	70,5	71,1	0,66	4	2,4	2,3	1,4	3,5	1,9	0,009	23,6
91.	DPIG 100LB/8	1,1	1,5	705	14,9	67,6	71,8	72,2	0,65	5,9	3,6	3,4	1,6	3,6	1,9	0,01	26,3
92.	DPIG 112M/8	1,5	2	720	19,9	72,5	76,2	76,8	0,71	6,9	4,2	4,0	1,9	4,6	2,3	0,0192	31
93.	2DPIG 132S/8	2,2	3	710	29,6	75,4	78,2	78	0,74	9,6	5,8	5,5	2,0	4,7	2,4	0,033	53
94.	2DPIG 132M/8	3	4	710	40,4	78,5	80,7	80	0,74	12,7	7,7	7,3	2,3	5,0	3,0	0,044	65
95.	DPIG 160MA/8	4	5,5	705	54,2	81,5	82,7	81,5	0,76	16,2	9,8	9,3	2,2	5,0	2,7	0,06	85
96.	DPIG 160MB/8	5,5	7,5	710	74	82,1	83,7	83	0,75	22,2	13,4	12,8	2,7	5,5	3,0	0,077	95
97.	DPIG 160L/8	7,5	10	705	102	84,5	85,5	84,5	0,78	28,6	17,3	16,4	2,7	5,8	3,0	0,102	115
98.	DPIG 180L/8	11	15	730	144	87,7	89,2	89	0,76	40,8	24,7	23,5	2,0	5,5	2,4	0,213	165
99.	2DPIG 200L/8	15	20	733	195	88,8	90	89,5	0,83	51	30,5	29,1	2,2	5,5	2,1	0,45	255
100.	2DPIG 225S/8	18,5	25	735	240	88,8	90	89,5	0,81	64	39	37	2,0	5,6	2,0	0,58	280
101.	2DPIG 225M/8	22	30	735	286	90,0	90,8	90,4	0,8	76	46	44	2,0	5,2	1,8	0,68	315
102.	2DPIG 250M/8	30	40	738	388	91,0	92	91,5	0,84	98	59	56	2,5	6,3	2,1	1,27	430
103.	2DPIG 280S/8	37	50	737	479	92,0	93,1	92,8	0,83	121	73	69	2,0	5,3	1,8	1,47	535
104.	2DPIG 280M/8	45	60	737	583	92,0	92,8	92,5	0,84	145	88	84	2,1	5,4	2,0	1,8	590
105.	DPIG 315S/8	55	75	735	715	92,0	93,0	92,7	0,81	184	111	106	2,0	5,3	1,9	2,16	720
106.	DPIG 315MA/8	75	100	737	972	92,5	93,5	93,2	0,82	246	149	142	2,5	6,2	1,9	2,29	750
107.	DPIG 315MB/8	90	125	737	1166	92,5	93,5	93,2	0,82	296	179	170	2,4	6,5	1,9	2,86	840

Totally Enclosed Motors IP 55

Item	Type	Rated output		Rated speed n_N [min ⁻¹]	Rated torque T_N [Nm]	Efficiency			Power factor $\cos \varphi_N$ [-]	Full load current			Locked rotor torque T_L/T_N [-]	Locked rotor current I_L/I_N [-]	Breakdown torque T_b/T_N [-]	Moment of inertia J [kgm ²]	Weight (IMB3) m [kg]
		P_N [kW]	[HP]			η_N [%] at % of full load	50%	75%		100%	I_N at rated voltage	[A] _{230V}					
2p=10 $n_s=600$ rpm f=50Hz																	
108.	2DPIG200LA/10	7,5	10	580	123	82,5	84	85	0,68	32,5	19,7	18,7	1,7	3,5	2,1	0,4	240
109.	2DPIG200LB/10	11	15	590	178	84,7	86,7	87,5	0,68	46	28,1	26,7	3,2	5,9	2,4	0,47	255
110.	2DPIG225S/10	13	18	592	210	87,5	89,3	90,5	0,67	54	32,5	31,0	1,8	3,8	2	0,6	280
111.	2DPIG225M/10	15	20	590	243	86	88	89	0,67	63	38,0	36,5	2,8	5,4	2	0,76	315
112.	2DPIG225M/10z	18,5	25	590	299	84,3	87,1	87,7	0,64	83	50	48	2,8	5,5	2,1	0,76	430
113.	2DPIG250M/10	22	30	592	355	87,5	89,6	90	0,70	88	53	50	3	5,8	2	1,27	525
114.	2DPIG280SA/10	30	40	585	489	85,3	87,3	88,8	0,71	119	72	69	2	4,5	1,7	1,35	565
115.	2DPIG280SB/10	37	50	583	606	87	90	91	0,75	136	82	78	1,9	4,5	1,5	1,61	630
116.	2DPIG280M/10	45	60	587	732	88	90,5	91,6	0,76	162	98	78	2	4,5	1,6	2,03	570
117.	DPIG315S/10z	55	75	583	901	88,0	90,5	91,5	0,75	201	122	116	1,7	4,7	1,9	2,86	840
118.	DPIG315M/10	75	100	583	1229	88,0	90,5	91,5	0,75	274	166	158	1,8	4,9	1,5	3,01	895
2p=12 $n_s=500$ rpm f=50Hz																	
119.	2DPIG200L/12	9	12	490	175	75,3	80,1	81,8	0,55	50	30,5	28,9	2,7	4,3	2,5	0,47	255
120.	2DPIG225S/12	11	15	490	214	83,1	85,0	86,0	0,63	51	31	29,3	1,7	3,5	1,7	0,58	315
121.	2DPIG225M/12	13	18	475	261	81,5	82,2	82,5	0,59	67	41	38,5	1,7	3,5	1,7	0,68	350
122.	2DPIG225M/12z	15	20	491	292	80,5	83,5	84,4	0,58	77	46,5	44	2,7	4,6	1,8	0,68	350
123.	2DPIG250M/12	18,5	25	490	361	84,0	86,0	87,8	0,65	81	49	47	1,7	3,5	1,8	1,27	430
124.	2DPIG280S/12	22	30	491	428	86,9	89,2	89,6	0,61	101	61	58	2,3	4,5	1,8	1,47	535
125.	2DPIG280M/12	30	40	490	585	85,6	88,2	89,0	0,62	136	83	78	1,8	3,5	1,8	1,8	570
126.	DPIG315S/12	37	50	492	718	87,5	89,9	90,4	0,58	177	107	102	2,6	4,5	1,9	2,29	730
127.	DPIG315MA/12	45	60	490	877	87,9	89,0	90,1	0,58	216	131	124	2	3,5	1,8	2,86	870
128.	DPIG315MB/12	55	75	490	1072	87,5	90,0	89,5	0,58	266	161	153	2,5	4,4	1,8	3,01	885

FOOT MOUNTED MOTORS - IM B3

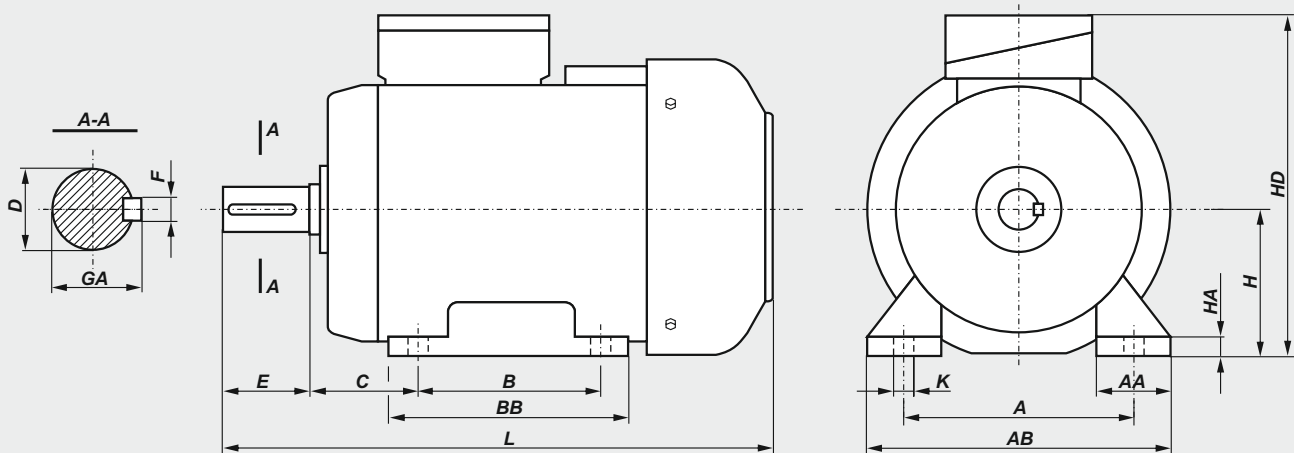
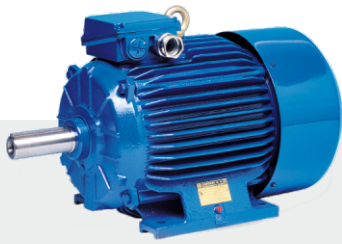

Motor type	A	B	C	D	E	F	GA	H	HA	K	AA	AB	BB	HD	L
DPIH 56A/2	90	71	36	9j6	20	3h9	10,2	56	7	5,8	30	110	92	154	183
DPIH 56A/4	90	71	36	9j6	20	3h9	10,2	56	7	5,8	30	110	92	154	183
DPIH 56B/2	90	71	36	9j6	20	3h9	10,2	56	7	5,8	30	110	92	154	193
DPIH 56B/4	90	71	36	9j6	20	3h9	10,2	56	7	5,8	30	110	92	154	193
DPIH 56B/6	90	71	36	9j6	20	3h9	10,2	56	7	5,8	30	110	92	154	193
DPIH 63-A	100	80	40	11j6	23	4h9	12,5	63	8,5	7	36	124	106	165	200
DPIH 63-B	100	80	40	11j6	23	4h9	12,5	63	8,5	7	36	124	106	165	210
DPIH 71-A	112	90	45	14j6	30	5h9	16	71	8	7	45	142	116	182	223
DPIH 71-B	112	90	45	14j6	30	5h9	16	71	8	7	45	142	116	182	245
DPIH 80-A	125	100	50	19j6	40	6h9	21,5	80	9	10	55	160	130	199	266
DPIH 80-B	125	100	50	19j6	40	6h9	21,5	80	9	10	55	160	130	199	278
DPIH 90S ...	140	100	56	24j6	50	8h9	27	90	10	10	50	170	153	220	305
DPIH 90L ...	140	125	56	24j6	50	8h9	27	90	10	10	50	170	153	220	330
DPIG 100L ...	160	140	63	28j6	60	8h9	31	100	14	12	45	200	172	240	376
DPIG 112M ...	190	140	70	28j6	60	8h9	31	112	14	12	54	230	174	276	384
2DPIG 132S ...	216	140	89	38k6	80	10h9	41	132	16	12	56	278	182	310	463
2DPIG 132S-2B	216	140	89	38k6	80	10h9	41	132	16	12	56	278	220	310	501
2DPIG 132M ...	216	178	89	38k6	80	10h9	41	132	16	12	56	278	220	310	501
DPIG 160M ...	254	210	108	42k6	110	12h9	45	160	20	15	60	305	256	370	612
DPIG 160L ...	254	254	108	42k6	110	12h9	45	160	20	15	60	305	300	370	656
DPIG 180M ...	279	241	121	48k6	110	14h9	51,5	180	26	15	70	350	320	408	705
DPIG 180L ...	279	279	121	48k6	110	14h9	51,5	180	26	15	70	350	320	408	705

FOOT MOUNTED MOTORS - IM B3

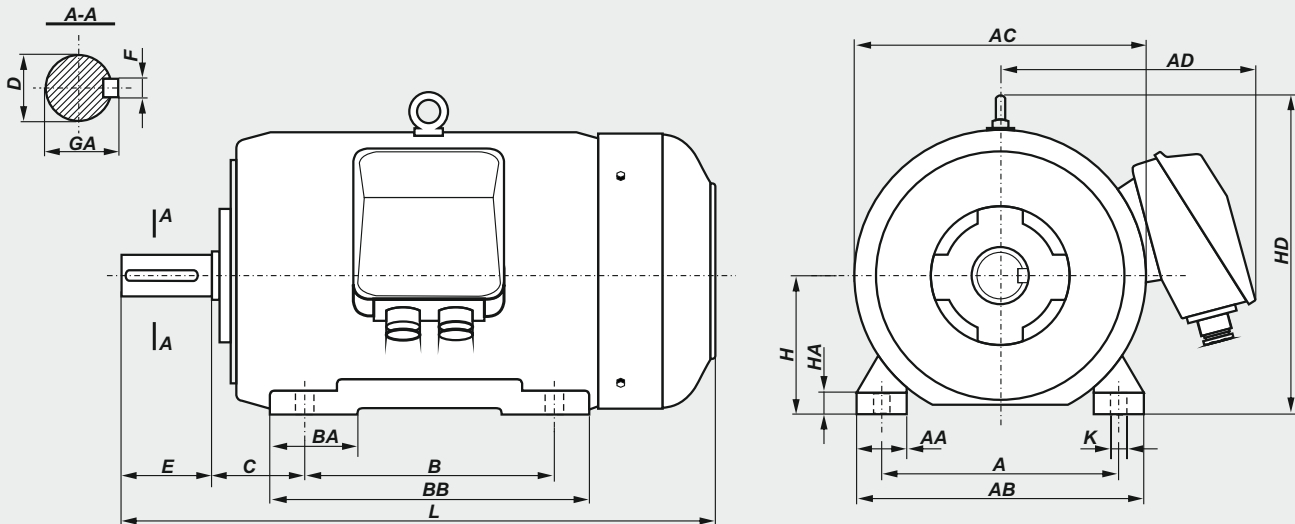

Motor type	A	B	C	D	E	F	GA	H	HA	K	AA	AB	AC	AD	BA	BB	HD	L
2DPIG 200 L..	318	305	133	55m6	110	16h9	59	200	32	19	80	400	450	355	100	380	485	825
2DPIG 225 S..	356	286	149	60m6	140	18h9	64	225	34	19	85	445	505	375	110	355	535	865
2DPIG 225 M2	356	311	149	55m6	110	16h9	59	225	34	19	85	445	505	375	110	380	535	860
2DPIG 225 M..	356	311	149	60m6	140	18h9	64	225	34	19	85	445	505	375	110	380	535	890
2DPIG 250 M2	406	349	168	60m6	140	18h9	64	250	36	24	90	495	540	415	120	420	590	965
2DPIG 250 M..	406	349	168	65m6	140	18h9	69	250	36	24	90	495	540	415	120	420	590	965
2DPIG 280 S2	457	368	190	65m6	140	18h9	69	280	40	24	100	560	620	450	165	520	660	1040
2DPIG 280 S..	457	368	190	75m6	140	20h9	79,5	280	40	24	100	560	620	450	165	520	660	1040
2DPIG 280 M2	457	419	190	65m6	140	18h9	69	280	40	24	100	560	620	450	165	520	660	1040
2DPIG 280 M..	457	419	190	75m6	140	20h9	79,5	280	40	24	100	560	620	450	165	520	660	1040
2DPIG 315 S2	508	406	216	65m6	140	18h9	69	315	46	28	105	610	620	450	190	560	695	1180
DPIG 315 S..	508	406	216	80m6	170	22h9	85	315	46	28	105	610	620	450	190	560	695	1210
DPIG 315 M2	508	457	216	65m6	140	18h9	69	315	46	28	105	610	620	450	190	560	695	1180
DPIG 315 M..	508	457	216	80m6	170	22h9	85	315	46	28	105	610	620	450	190	560	695	1210

FOOT/FLANGE MOUNTED MOTORS - IM B35

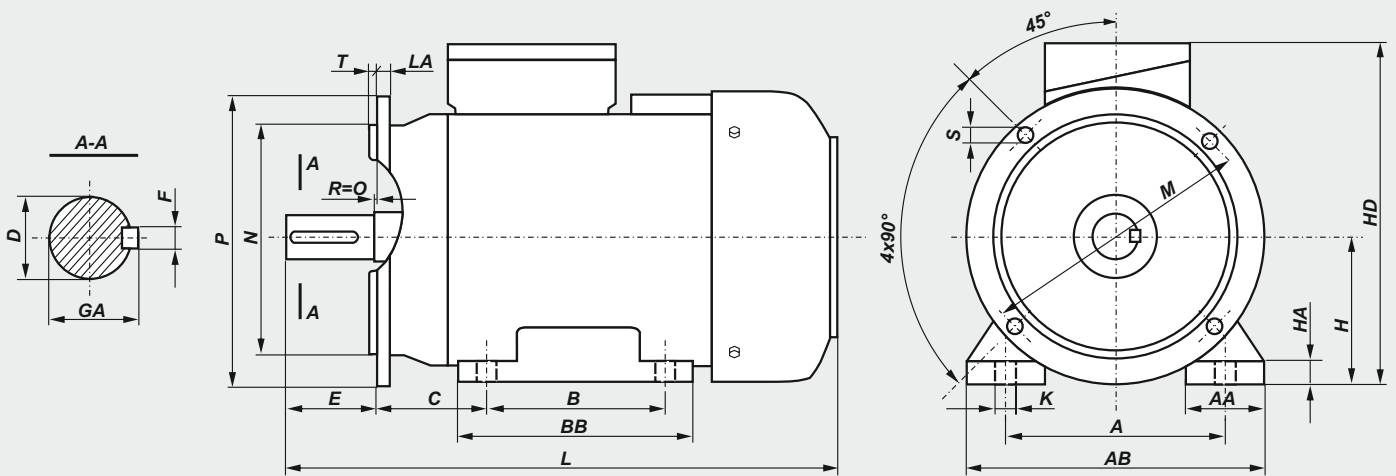

Motor type	A	B	C	D	E	F	GA	H	HA	K	AA	AB	BB	HD	L	LA	M	N	P	T	S
DPIH 56A/2	90	71	36	9j6	20	3h9	10,2	56	7	8	30	110	92	154	183	8	100	80j6	120	3	7
DPIH 56A/4	90	71	36	9j6	20	3h9	10,2	56	7	8	30	110	92	154	183	8	100	80j6	120	3	7
DPIH 56B/2	90	71	36	9j6	20	3h9	10,2	56	7	8	30	110	92	154	193	8	100	80j6	120	3	7
DPIH 56B/4	90	71	36	9j6	20	3h9	10,2	56	7	8	30	110	92	154	193	8	100	80j6	120	3	7
DPIH 56B/6	90	71	36	9j6	20	3h9	10,2	56	7	8	30	110	92	154	193	8	100	80j6	120	3	7
DPIH 63-.A	100	80	40	11j6	23	4h9	12,5	63	8,5	10	36	124	106	165	200	9	115	95j6	140	3	10
DPIH 63-.B	100	80	40	11j6	23	4h9	12,5	63	8,5	10	36	124	106	165	210	9	115	95j6	140	3	10
DPIH 71-.A	112	90	45	14j6	30	5h9	16	71	8	10	45	142	116	182	223	9	130	110j6	160	3,5	10
DPIH 71-.B	112	90	45	14j6	30	5h9	16	71	8	10	45	142	116	182	245	9	130	110j6	160	3,5	10
DPIH 80-.A	125	100	50	19j6	40	6h9	21,5	80	9	10	55	160	130	199	266	10	165	130j6	200	3,5	12
DPIH 80-.B	125	100	50	19j6	40	6h9	21,5	80	9	10	55	160	130	199	278	10	165	130j6	200	3,5	12
DPIH 90S ...	140	100	56	24j6	50	8h9	27	90	10	10	50	170	153	220	305	8	165	130j6	200	3,5	12
DPIH 90L ...	140	125	56	24j6	50	8h9	27	90	10	10	50	170	153	220	330	8	165	130j6	200	3,5	12
DPIG 100L ...	160	140	63	28j6	60	8h9	31	100	14	12	45	200	172	240	376	11	215	180j6	250	4	15
DPIG 112M ...	190	140	70	28j6	60	8h9	31	112	14	12	54	230	174	276	384	12	215	180j6	250	4	15
2DPIG 132S...	216	140	89	38k6	80	10h9	41	132	16	12	56	278	182	310	463	12	265	230j6	300	4	15
2DPIG 132S-2B	216	140	89	38k6	80	10h9	41	132	16	12	56	278	220	310	501	12	265	230j6	300	4	15
2DPIG 132M...	216	178	89	38k6	80	10h9	41	132	16	12	56	278	220	310	501	12	265	230j6	300	4	15
DPIG 160M ...	254	210	108	42k6	110	12h9	45	160	20	15	60	305	256	370	612	13	300	250j6	350	5	19
DPIG 160L ...	254	254	108	42k6	110	12h9	45	160	20	15	60	305	300	370	656	13	300	250j6	350	5	19
DPIG 180M ...	279	241	121	48k6	110	14h9	51,5	180	26	15	70	350	320	408	705	13	300	250j6	350	5	19
DPIG 180L ...	279	279	121	48k6	110	14h9	51,5	180	26	15	70	350	320	408	705	13	300	250j6	350	5	19

FOOT/FLANGE MOUNTED MOTORS - IM B35

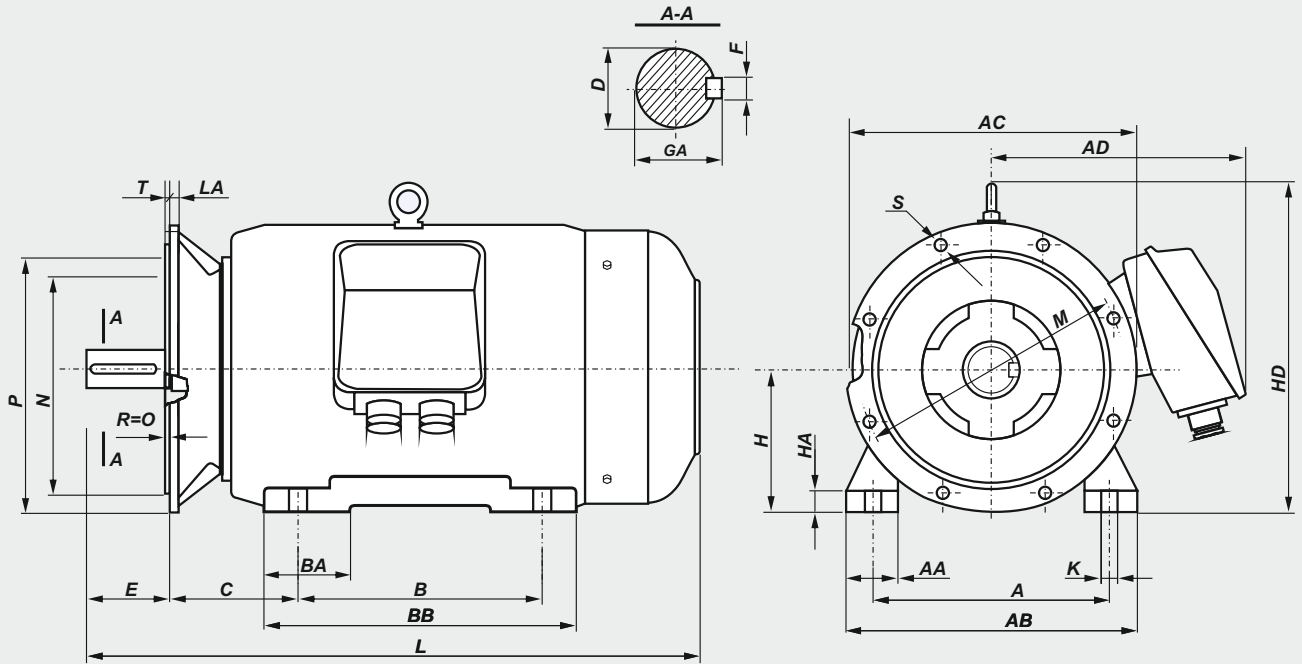

Motor type	A	B	C	D	E	F	GA	H	HA	K	AA	AB	AC	AD	BA	BB	HD	L	LA	M	N	P	T	S	
2DPIG 200 L..	318	305	133	55m6	110	16h9	59	200	32	19	80	400	450	355	100	380	485	825	16,5	350	300j6	400	5	18	4
2DPIG 225 S..	356	286	149	60m6	140	18h9	64	225	34	19	85	445	505	375	110	355	535	870	18	400	350j6	450	5	18	8
2DPIG 225 M2	356	311	149	55m6	110	16h9	59	225	34	19	85	445	505	375	110	380	535	865	18	400	350j6	450	5	18	8
2DPIG 225 M..	356	311	149	60m6	140	18h9	64	225	34	19	85	445	505	375	110	380	535	895	18	400	350j6	450	5	18	8
2DPIG 250 M2	406	349	168	60m6	140	18h9	64	250	36	24	90	495	540	415	120	420	590	965	19	500	450j6	550	5	18	8
2DPIG 250 M..	406	349	168	65m6	140	18h9	69	250	36	24	90	495	540	415	120	420	590	965	19	500	450j6	550	5	18	8
2DPIG 280 S2	457	368	190	65m6	140	18h9	69	280	40	24	100	560	620	450	165	520	660	1040	20	500	450j6	550	5	18	8
2DPIG 280 S..	457	368	190	75m6	140	20h9	79,5	280	40	24	100	560	620	450	165	520	660	1040	20	500	450j6	550	5	18	8
2DPIG 280 M2	457	419	190	65m6	140	18h9	69	280	40	24	100	560	620	450	165	520	660	1040	20	500	450j6	550	5	18	8
2DPIG 280 M..	457	419	190	75m6	140	20h9	79,5	280	40	24	100	560	620	450	165	520	660	1040	20	500	450j6	550	5	18	8
DPIG 315 S2	508	406	216	65m6	140	18h9	69	315	46	28	105	610	620	450	190	560	695	1180	22	600	550js6	660	6	22	8
DPIG 315 S..	508	406	216	80m6	170	22h9	85	315	46	28	105	610	620	450	190	560	695	1210	22	600	550js6	660	6	22	8
DPIG 315 M2	508	457	216	65m6	140	18h9	69	315	46	28	105	610	620	450	190	560	695	1180	22	600	550js6	660	6	22	8
DPIG 315 M..	508	457	216	80m6	170	22h9	85	315	46	28	105	610	620	450	190	560	695	1210	22	600	550js6	660	6	22	8

FOOT/FLANGE MOUNTED MOTORS - IM B34

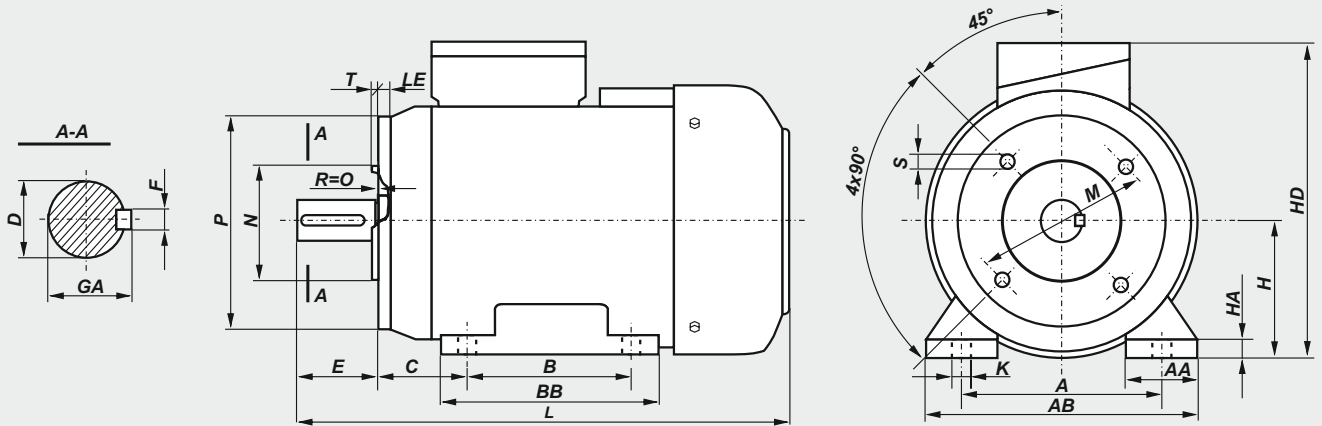

Motor type	Flange	A	AA	B	C	D	E	F	GA	H	HA	K	M	N	P	S	LE	T	HD	L
DPIH 56A/2	B14/C1	90	30	71	36	9j6	20	3h9	10,2	56	7	8	85	70j6	105	M6	15	2,5	154	183
DPIH 56A/2	B14/C2	90	30	71	36	9j6	20	3h9	10,2	56	7	8	65	50j6	80	M5	12,5	2,5	154	183
DPIH 56A/4	B14/C1	90	30	71	36	9j6	20	3h9	10,2	56	7	8	85	70j6	105	M6	15	2,5	154	183
DPIH 56A/4	B14/C2	90	30	71	36	9j6	20	3h9	10,2	56	7	8	65	50j6	80	M5	12,5	2,5	154	183
DPIH 56B/2	B14/C1	90	30	71	36	9j6	20	3h9	10,2	56	7	8	85	70j6	105	M6	15	2,5	154	193
DPIH 56B/2	B14/C2	90	30	71	36	9j6	20	3h9	10,2	56	7	8	65	50j6	80	M5	12,5	2,5	154	193
DPIH 56B/4	B14/C1	90	30	71	36	9j6	20	3h9	10,2	56	7	8	85	70j6	105	M6	15	2,5	154	193
DPIH 56B/4	B14/C2	90	30	71	36	9j6	20	3h9	10,2	56	7	8	65	50j6	80	M5	12,5	2,5	154	193
DPIH 56B/6	B14/C1	90	30	71	36	9j6	20	3h9	10,2	56	7	8	85	70j6	105	M6	15	2,5	154	193
DPIH 56B/6	B14/C2	90	30	71	36	9j6	20	3h9	10,2	56	7	8	65	50j6	80	M5	12,5	2,5	154	193
DPIH 63-.A	B14/C1	100	36	80	40	11j6	23	4h9	12,5	63	8,5	10	100	80j6	120	M6	14	3	165	200
DPIH 63-.A	B14/C2	100	36	80	40	11j6	23	4h9	12,5	63	8,5	10	75	60j6	90	M5	9,5	2,5	165	200
DPIH 63-.B	B14/C1	100	36	80	40	11j6	23	4h9	12,5	63	8,5	10	100	80j6	120	M6	14	3	165	210
DPIH 63-.B	B14/C2	100	36	80	40	11j6	23	4h9	12,5	63	8,5	10	75	60j6	90	M5	9,5	2,5	165	210
DPIH 71-.A	B14/C1	112	45	90	45	14j6	30	5h9	16	71	8	10	115	95j6	140	M8	14	3	182	223
DPIH 71-.A	B14/C2	112	45	90	45	14j6	30	5h9	16	71	8	10	85	70j6	105	M6	12	2,5	182	223
DPIH 71-.B	B14/C1	112	45	90	45	14j6	30	5h9	16	71	8	10	115	95j6	140	M8	14	3	182	245
DPIH 71-.B	B14/C2	112	45	90	45	14j6	30	5h9	16	71	8	10	85	70j6	105	M6	12	2,5	182	245
DPIH 80-.A	B14/C1	125	55	100	50	19j6	40	6h9	21,5	80	9	10	130	110j6	160	M8	14	3,5	199	266
DPIH 80-.A	B14/C2	125	55	100	50	19j6	40	6h9	21,5	80	9	10	100	80j6	120	M6	12	3	199	266
DPIH 80-.B	B14/C1	125	55	100	50	19j6	40	6h9	21,5	80	9	10	130	110j6	160	M8	14	3,5	199	278
DPIH 80-.B	B14/C2	125	55	100	50	19j6	40	6h9	21,5	80	9	10	100	80j6	120	M6	12	3	199	278
DPIH 90S ...	B14/C1	140	50	100	56	24j6	50	8h9	27	90	10	10	130	110j6	160	M8	10	3,5	220	305
DPIH 90S ...	B14/C2	140	50	100	56	24j6	50	8h9	27	90	10	10	115	95j6	140	M8	10	3	220	305
DPIH 90L ...	B14/C1	140	50	125	56	24j6	50	8h9	27	90	10	10	130	110j6	160	M8	10	3,5	220	330
DPIH 90L ...	B14/C2	140	50	125	56	24j6	50	8h9	27	90	10	10	115	95j6	140	M8	10	3	220	330
DPIG 100L ...	B14/C1	160	45	140	63	28j6	60	8h9	31	100	14	12	165	130j6	200	M10	12	3,5	240	376
DPIG 100L ...	B14/C2	160	45	140	63	28j6	60	8h9	31	100	14	12	130	110j6	160	M8	12	3,5	240	376
DPIG 112M ...	B14/C1	190	54	140	70	28j6	60	8h9	31	112	14	12	165	130j6	200	M10	12	3,5	276	384
DPIG 112M ...	B14/C2	190	54	140	70	28j6	60	8h9	31	112	14	12	130	110j6	160	M8	12	3,5	276	384
2DPIG132S ...	B14/C1	216	56	140	89	38k6	80	10h9	41	132	16	12	215	180j6	250	M12	12	4	310	463
2DPIG132S ...	B14/C2	216	56	140	89	38k6	80	10h9	41	132	16	12	165	130j6	200	M10	12	3,5	310	463
2DPIG132S-2B	B14/C1	216	56	140	89	38k6	80	10h9	41	132	16	12	215	180j6	250	M12	12	4	310	501
2DPIG132S-2B	B14/C2	216	56	140	89	38k6	80	10h9	41	132	16	12	165	130j6	200	M10	12	3,5	310	501
2DPIG 132M...	B14/C1	216	56	140	89	38k6	80	10h9	41	132	16	12	215	180j6	250	M12	12	4	310	501
2DPIG 132M...	B14/C2	216	56	140	89	38k6	80	10h9	41	132	16	12	165	130j6	200	M10	12	3,5	310	501

FLANGE MOUNTED MOTORS - IM B5

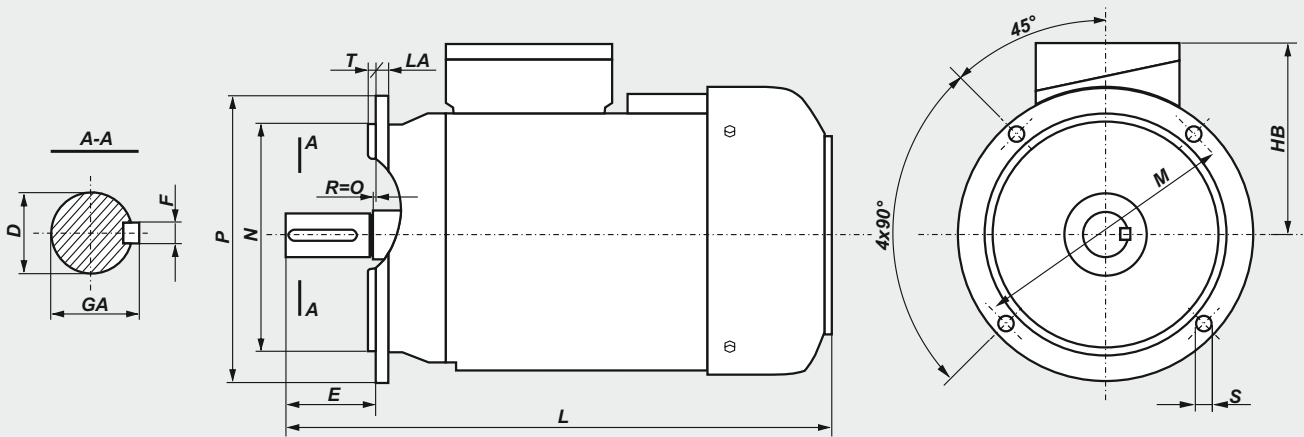

Type of motor	D	E	F	GA	M	N	P	LA	T	S	HB	L
DPIH 56A/2	9j6	20	3h9	10,2	100	80j6	120	8	3	7	98	183
DPIH 56A/4	9j6	20	3h9	10,2	100	80j6	120	8	3	7	98	183
DPIH 56B/2	9j6	20	3h9	10,2	100	80j6	120	8	3	7	98	193
DPIH 56B/4	9j6	20	3h9	10,2	100	80j6	120	8	3	7	98	193
DPIH 56B/6	9j6	20	3h9	10,2	100	80j6	120	8	3	7	98	193
DPIH 63- .A	11j6	23	4h9	12,5	115	95j6	140	9	3	10	102	200
DPIH 63- .B	11j6	23	4h9	12,5	115	95j6	140	9	3	10	102	210
DPIH 71- .A	14j6	30	5h9	16	130	110j6	160	9	3,5	10	111	223
DPIH 71- .B	14j6	30	5h9	16	130	110j6	160	9	3,5	10	111	245
DPIH 80- .A	19j6	40	6h9	21,5	165	130j6	200	10	3,5	12	119	266
DPIH 80- .B	19j6	40	6h9	21,5	165	130j6	200	10	3,5	12	119	278
DPIH 90S ...	24j6	50	8h9	27	165	130j6	200	8	3,5	12	130	305
DPIH 90L ...	24j6	50	8h9	27	165	130j6	200	8	3,5	12	130	330
DPIG 100L ...	28j6	60	8h9	31	215	180j6	250	11	4	15	140	376
DPIG 112M ...	28j6	60	8h9	31	215	180j6	250	12	4	15	164	384
2DPIG 132S ...	38k6	80	10h9	41	265	230j6	300	12	4	15	178	463
2DPIG 132S-2B	38k6	80	10h9	41	265	230j6	300	12	4	15	178	501
2DPIG 132M ...	38k6	80	10h9	41	265	230j6	300	12	4	15	178	501
DPIG 160M ...	42k6	110	12h9	45	300	250j6	350	13	5	19	210	612
DPIG 160L ...	42k6	110	12h9	45	300	250j6	350	13	5	19	210	656
DPIG 180M ...	48k6	110	14h9	51,5	300	250j6	350	13	5	19	228	705
DPIG 180L ...	48k6	110	14h9	51,5	300	250j6	350	13	5	19	228	705

FLANGE MOUNTED MOTORS - IM B5, IM V1

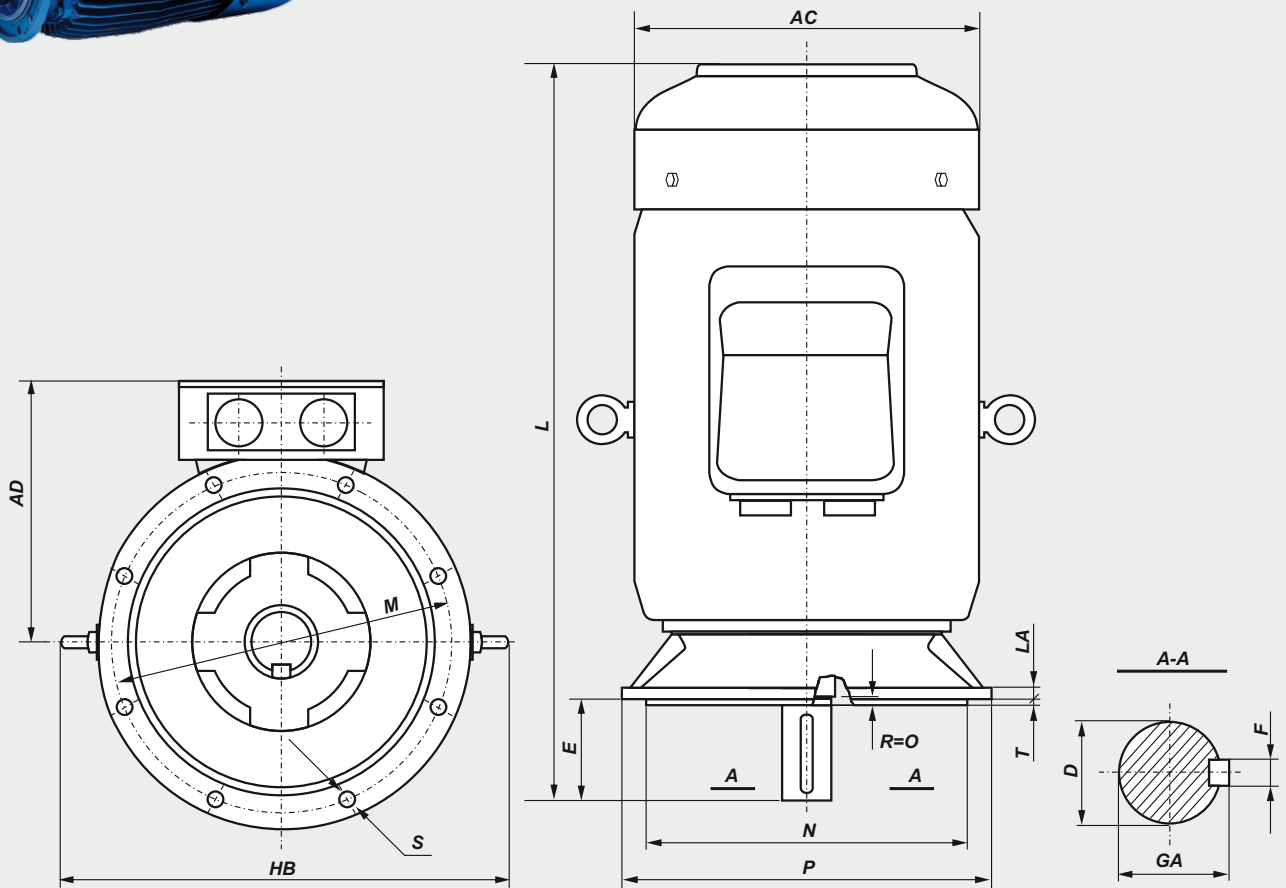

Motor type	D	E	F	GA	AC	AD	HB	L	LA	M	N	P	T	S	
2DPIG 200 L...	55m6	110	16h9	59	450	355	570	825	16,5	350	300j6	400	5	18	4
2DPIG 225 S...	60m6	140	18h9	64	505	375	620	870	18	400	350j6	450	5	18	8
2DPIG 225 M2	55m6	110	16h9	59	505	375	620	865	18	400	350j6	450	5	18	8
2DPIG 225 M...	60m6	140	18h9	64	505	375	620	895	18	400	350j6	450	5	18	8
2DPIG 250 M2	60m6	140	18h9	64	540	415	675	965	19	500	450j6	550	5	18	8
2DPIG 250 M...	65m6	140	18h9	69	540	415	675	965	19	500	450j6	550	5	18	8
2DPIG 280 S2	65m6	140	18h9	69	620	450	755	1040	20	500	450j6	550	5	18	8
2DPIG 280 S...	75m6	140	20h9	79,5	620	450	755	1040	20	500	450j6	550	5	18	8
2DPIG 280 M2	65m6	140	18h9	69	620	450	755	1040	20	500	450j6	550	5	18	8
2DPIG 280 M...	75m6	140	20h9	79,5	620	450	755	1040	20	500	450j6	550	5	18	8
DPIG 315 S2	65m6	140	18h9	69	620	450	790	1180	22	600	550js6	660	6	22	8
DPIG 315 S...	80m6	170	22h9	85	620	450	790	1210	22	600	550js6	660	6	22	8
DPIG 315 M2	65m6	140	18h9	69	620	450	790	1180	22	600	550js6	660	6	22	8
DPIG 315 M...	80m6	170	22h9	85	620	450	790	1210	22	600	550js6	660	6	22	8

FLANGE MOUNTED MOTORS - IM B14

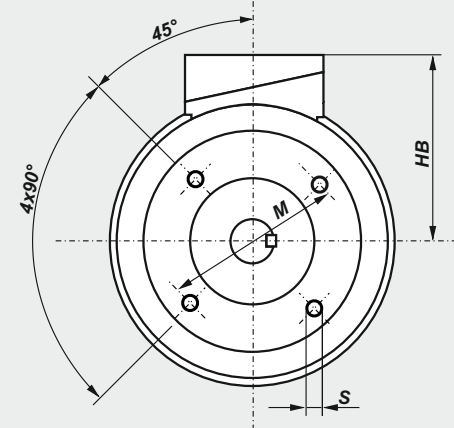
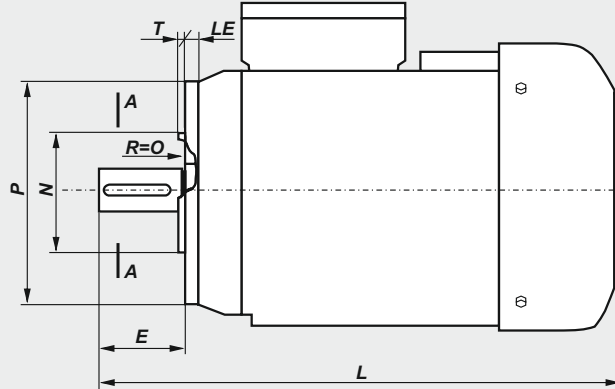
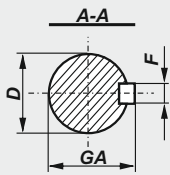

Motor type	Flange	D	E	F	GA	M	N	P	S	T	LE	HB	L
DPIH 56A/2	B14/C1	9j6	20	3h9	10,2	85	70j6	105	M6	2,5	15	98	183
DPIH 56A/2	B14/C2	9j6	20	3h9	10,2	65	50j6	80	M5	2,5	12,5	98	183
DPIH 56A/4	B14/C1	9j6	20	3h9	10,2	85	70j6	105	M6	2,5	15	98	183
DPIH 56A/4	B14/C2	9j6	20	3h9	10,2	65	50j6	80	M5	2,5	12,5	98	183
DPIH 56B/2	B14/C1	9j6	20	3h9	10,2	85	70j6	105	M6	2,5	15	98	193
DPIH 56B/2	B14/C2	9j6	20	3h9	10,2	65	50j6	80	M5	2,5	12,5	98	193
DPIH 56B/4	B14/C1	9j6	20	3h9	10,2	85	70j6	105	M6	2,5	15	98	193
DPIH 56B/4	B14/C2	9j6	20	3h9	10,2	65	50j6	80	M5	2,5	12,5	98	193
DPIH 56B/6	B14/C1	9j6	20	3h9	10,2	85	70j6	105	M6	2,5	15	98	193
DPIH 56B/6	B14/C2	9j6	20	3h9	10,2	65	50j6	80	M5	2,5	12,5	98	193
DPIH 63- .A	B14/C1	11j6	23	4h9	12,5	100	80j6	120	M6	3	14	102	200
DPIH 63- .A	B14/C2	11j6	23	4h9	12,5	75	60j6	90	M5	2,5	9,5	102	200
DPIH 63- .B	B14/C1	11j6	23	4h9	12,5	100	80j6	120	M6	3	14	102	210
DPIH 63- .B	B14/C2	11j6	23	4h9	12,5	75	60j6	90	M5	2,5	9,5	102	210
DPIH 71- .A	B14/C1	14j6	30	5h9	16	115	95j6	140	M8	3	14	111	223
DPIH 71- .A	B14/C2	14j6	30	5h9	16	85	70j6	105	M6	2,5	12	111	223
DPIH 71- .B	B14/C1	14j6	30	5h9	16	115	95j6	140	M8	3	14	111	245
DPIH 71- .B	B14/C2	14j6	30	5h9	16	85	70j6	105	M6	2,5	12	111	245
DPIH 80- .A	B14/C1	19j6	40	6h9	21,5	130	110j6	160	M8	3,5	14	119	266
DPIH 80- .A	B14/C2	19j6	40	6h9	21,5	100	80j6	120	M6	3	12	119	266
DPIH 80- .B	B14/C1	19j6	40	6h9	21,5	130	110j6	160	M8	3,5	14	119	278
DPIH 80- .B	B14/C2	19j6	40	6h9	21,5	100	80j6	120	M6	3	12	119	278
DPIH 90S ...	B14/C1	24j6	50	8h9	27	130	110j6	160	M8	3,5	10	130	305
DPIH 90S ...	B14/C2	24j6	50	8h9	27	115	95j6	140	M8	3	10	130	305
DPIH 90L ...	B14/C1	24j6	50	8h9	27	130	110j6	160	M8	3,5	10	130	330
DPIH 90L ...	B14/C2	24j6	50	8h9	27	115	95j6	140	M8	3	10	130	330
DPIG 100L ...	B14/C1	28j6	60	8h9	31	165	130j6	200	M10	3,5	12	140	376
DPIG 100L ...	B14/C2	28j6	60	8h9	31	130	110j6	160	M8	3,5	12	140	376
DPIG 112M ...	B14/C1	28j6	60	8h9	31	165	130j6	200	M10	3,5	12	164	384
DPIG 112M ...	B14/C2	28j6	60	8h9	31	130	110j6	160	M8	3,5	12	164	384
2DPIG 132S ...	B14/C1	38k6	80	10h9	41	215	180j6	250	M12	4	12	178	463
2DPIG 132S ...	B14/C2	38k6	80	10h9	41	165	130j6	200	M10	3,5	12	178	463
2DPIG 132S-2B	B14/C1	38k6	80	10h9	41	215	180j6	250	M12	4	12	178	501
2DPIG 132S-2B	B14/C2	38k6	80	10h9	41	165	130j6	200	M10	3,5	12	178	501
2DPIG 132M ...	B14/C1	38k6	80	10h9	41	215	180j6	250	M12	4	12	178	501
2DPIG 132M ...	B14/C2	38k6	80	10h9	41	165	130j6	200	M10	3,5	12	178	501

List of Motor parts

Frame Size: 56÷80

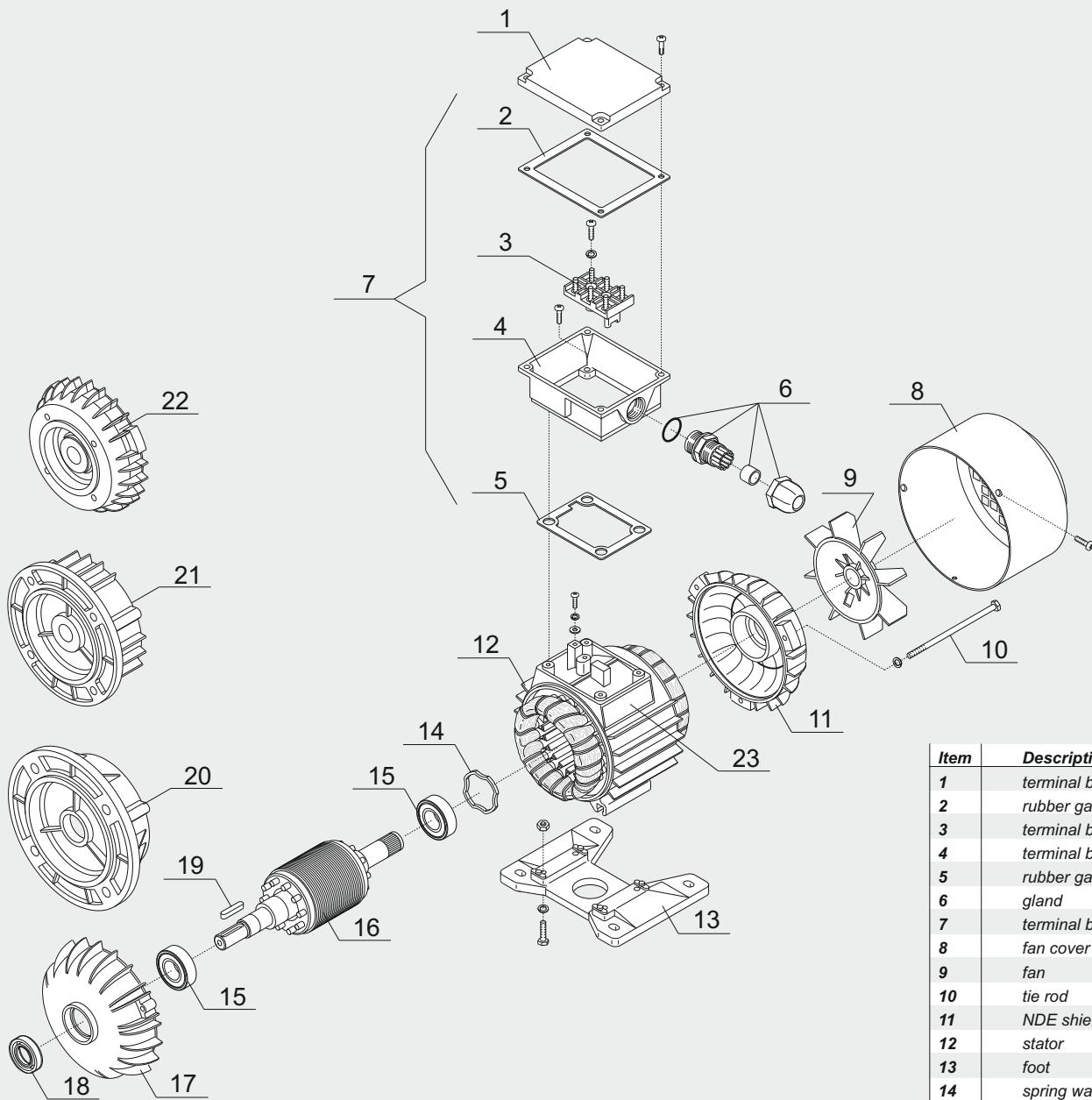

Item	Description
1	terminal box cover
2	rubber gasket
3	terminal board
4	terminal box
5	rubber gasket
6	gland
7	terminal box complete
8	fan cover
9	fan
10	tie rod
11	NDE shield
12	stator
13	foot
14	spring washer
15	bearing
16	rotor
17	DE shield
18	shaft seal
19	key
20	flange B5
21	flange B14/C1
22	flange B14/C2
23	name plate

DE - drive end
NDE - non drive end

Frame Size: 90÷180

List of Motor parts

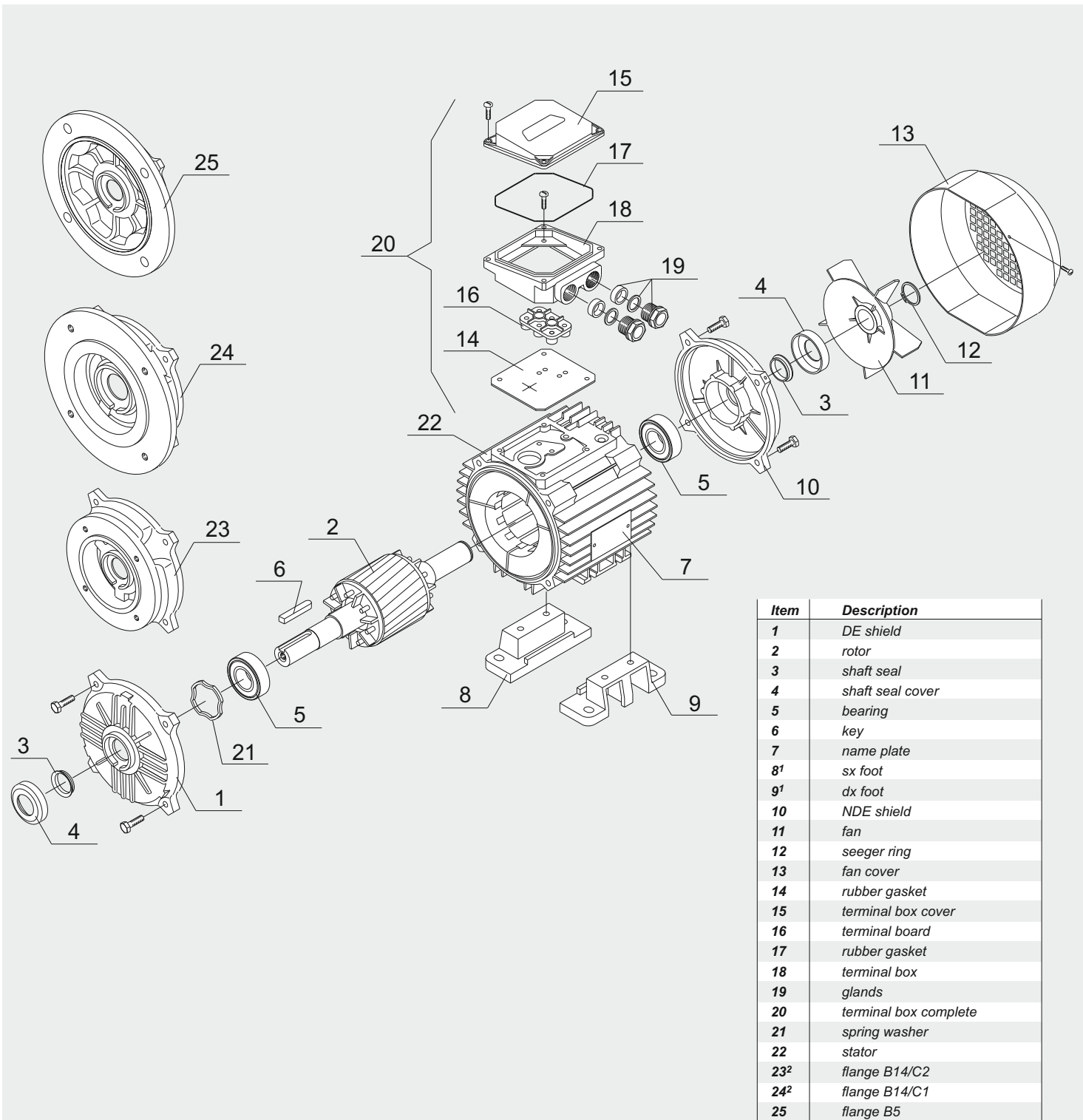

Item	Description
1	DE shield
2	rotor
3	shaft seal
4	shaft seal cover
5	bearing
6	key
7	name plate
8 ¹	sx foot
9 ¹	dx foot
10	NDE shield
11	fan
12	seeger ring
13	fan cover
14	rubber gasket
15	terminal box cover
16	terminal board
17	rubber gasket
18	terminal box
19	glands
20	terminal box complete
21	spring washer
22	stator
23 ²	flange B14/C2
24 ²	flange B14/C1
25	flange B5

DE - drive end
NDE - non drive end

1 - for frame size 132 feet can be screwed or integrated with the motor housing, for frame size 160 -180 feet are integrated with the motor housing.
2 - only for frame size 90 - 132.

List of Motor parts

Frame Size: 200÷315

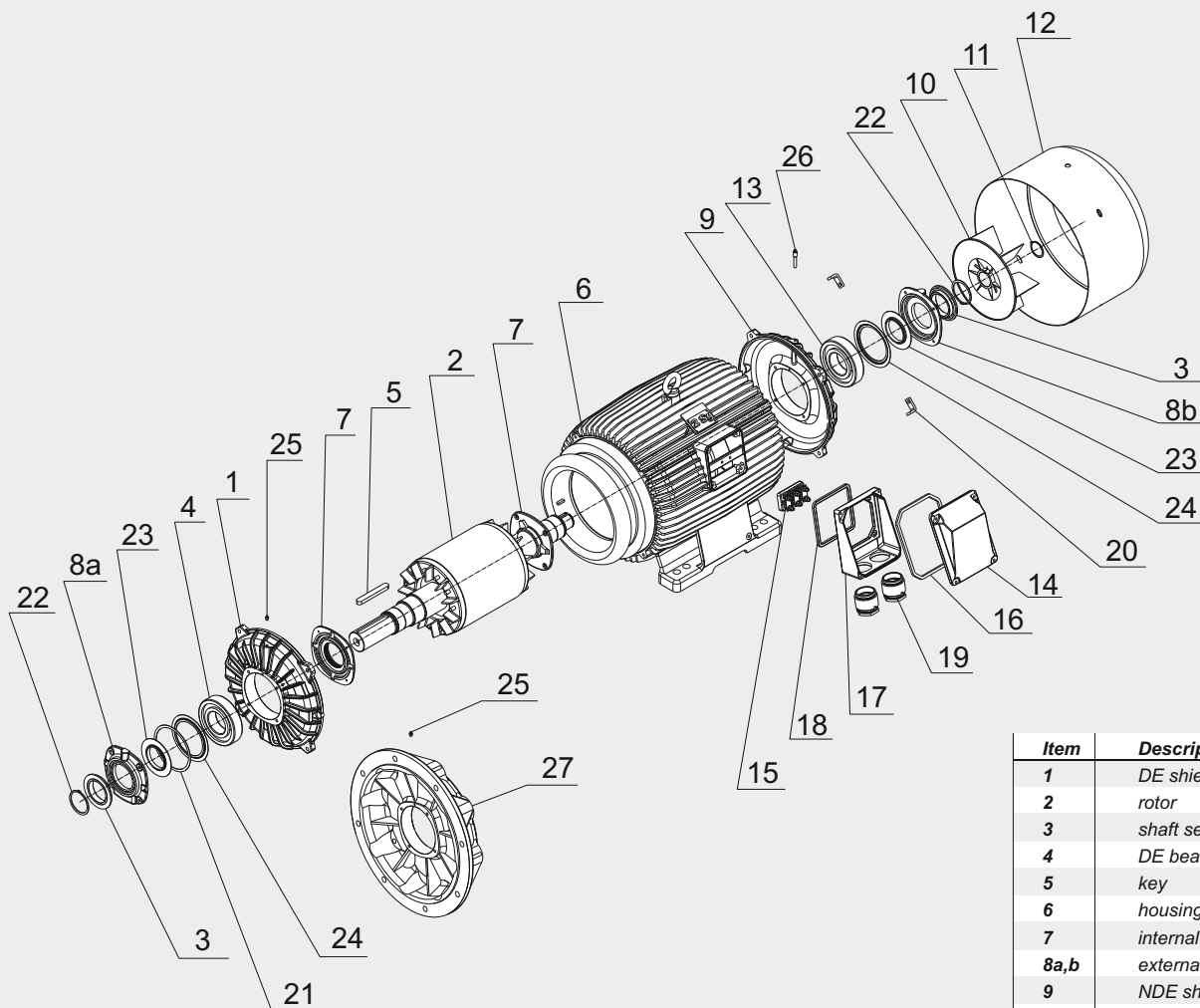

Item	Description
1	DE shield
2	rotor
3	shaft seal
4	DE bearing
5	key
6	housing with feet
7	internal bearing cap
8a,b	external bearing cap
9	NDE shield
10	fan
11	seeger ring
12	fan cover
13	NDE bearing
14	terminal box cover
15	terminal cover support
16	rubber gasket
17	terminal box housing
18	rubber gasket
19	cable glands
20	fan cover support
21	spring washer
22	seeger ring
23	grease shield *
24	bearing internal ring *
25	DE grease nipple
26	NDE grease nipple
27	flange B5

DE - drive end
NDE - non drive end









* only for size 315

NOTICE

PRODUCT RANGE

GENERAL PURPOSE 3-PHASE INDUCTION MOTORS	Three-phase motors with squirrel-cage rotor series (2)Sg(m), Sh. High efficiency motors series 2SIE, 3SIE and 4SIE (Efficiency classes IE1, IE2, IE3, IE4)	from 0,04kW up to 1400kW	general purpose, pumps, fans, compressors, specific requirements relating to the highest efficiency	
GENERAL PURPOSE 1-PHASE INDUCTION MOTORS	Single-phase motors with squirrel-cage rotor series SEh(R), SEMh(R). - motors with standard starting torque - motors with increased starting torque - motors with high starting torque.	from 0,04kW up to 4kW	general purpose, pumps, fans, compressors, wood machines, machines and devices for food processing, mixers for building	
HIGH VOLTAGE INDUCTION MOTORS	Three-phase squirrel-cage high voltage and high efficiency motors series Sh with cast-iron housing. High voltage motors with module construction (steel/welded housing) series Sf-E and Sfw.	from 160kW up to 3150kW	general industrial use, drives used for own needs of power plants (pumps, fans, coal mills, conveyors)	
BRAKE MOTORS	Three-phase and single-phase brake motors with AC and DC brakes.	from 0,04kW up to 160kW	applied in case of necessity to stop the motor suddenly	
MOTORS WITH FOREIGN COOLING	Three-phase 3-phase induction motors with foreign cooling.	from 0,06kW up to 250kW	drives adapted for speed regulation by frequency converter	
EXPLOSION-PROOF MOTORS	Increased safety motors. Flame-proof motors.	from 0,06kW up to 22kW from 0,75kW up to 315kW	adapted for operation in areas endangered by explosion (without methane) application in an atmosphere where a mixture of explosive gas and vapours may occur	
NEMA MOTORS	Low voltage NEMA motors SIE series (in compliance with the NEMA PREMIUM requirements).	from 1HP up to 250HP	general industrial application, pumps, fans	
TRACTION MOTORS	Traction motors and traction generators.	from 50kW up to 1500kW	various traction vehicles: trams (including low-deck trams), trolleybuses, subway and locomotives	

PRODUCT RANGE

SUBMERSIBLE MOTORS	Submersible motors with protection Ip68 Type TMP	from 5,5kW up to 22kW 4 poles standard with 10m connection cable and 6m protection tube with special shaft (long or short)	PUMP DIRVE Agriculture, liquid manure, biogas, wastewater , sewage plant	
SUBMERSIBLE MOTORS	Special motors desinged and produced from FFD in close coordination with and especially for our customers. From the first idea to the final production.	for example: Submersible motor type: dSKLS (11 and 15kW) flame proof desing IIG Ex dIIA T4	MIXER Agriculture, liquid manure, biogas, wastewater , sewage plant	
HOLLOW SHAFT MOTORS	Three-phase induction motors with hollow shaft	Frame size: 100 up to 250 Poles: 2, 4, 6, 8, 12 and multiple speed	Suitable for agitators driving with special flange and hollow shaft (without propeller and shaft)	
MARINE MOTORS	Three-phase induction motors	PRS - polish register of shipping GL - German Lloyd ´s LRS - Lloyd ´s Register of shipping DNV - Det Norske Veritas ABS - American Bureau of shipping BV - Bureau Veritas RMRS - Russian Maritime Register of Shipping	Motors designed for use on ships. On deck or under deck. The motors are made to withstand aggressive environments such a salt mist.	
MOTORS FOR INDUSTRIAL FURNANCE AND BLOWERS	Three-phase induction motors	Motors used for air circulation up to 1200°C air temperature	Motors works in drying plants	
COOLING MEDIUM PUMPS	Three phase pumps or Single phase pumps	DKP with 115W EKP with 100W Dip length: 86mm, 120mm, 170mm, 220mm, 270mm 220-250/380-440V 50/60Hz	Work like centrifugal pumps. These pumps are quite resistant to the pollution of coolants. Manufactured in with 5 different dip length.	
BRAKES	Electromagnetic brakes	H2SP, HPS, 2H2SP, H2SPX H2SP..AT - quiet operation HPS..AT - quiet operation STE, STK - quiet operation 2H2SP..BT - quiet operation, NE - high level of protection NEX - explosion-proof version HZg - alternating current brakes	High standard and high repeatability even with large number of actuations.	
REPAIRS AND SERVICE	Electrical and mechanical repairs of all motor types Service and testing of all motor types Also motors from other manufacturers	for example: - new winding - new bearings - new shafts - new PTC, Pt100 or bi-metal switch - new painting (all RAL colors) - new name plate - Motor routine test	We are using only high quality materials for motor repair.	

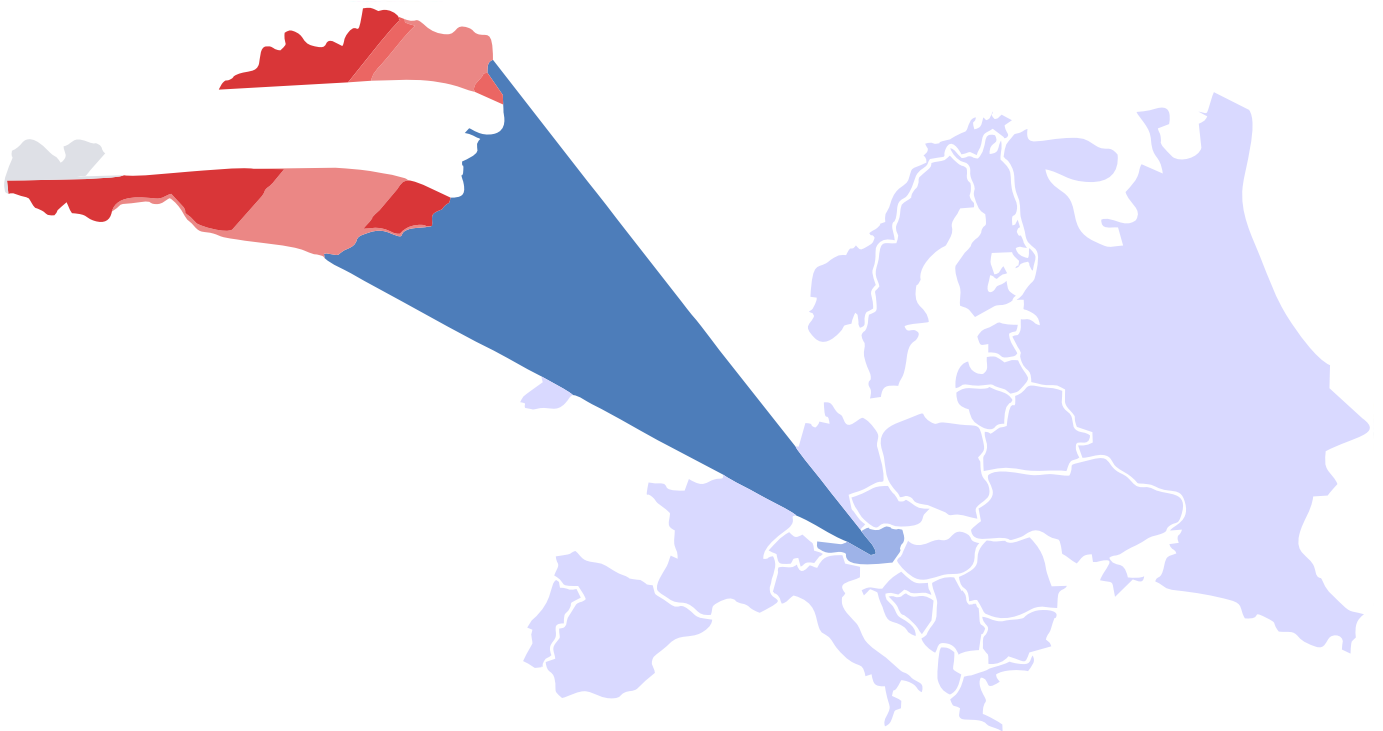

**FFD locadet in the heart
of Europe, AUSTRIA!**

FRANK & DVORAK

Elektromaschinenbau- und Vertriebsgesellschaft m.b.H. u. Co.K

CONTACT ADDRESS:

Industriestraße 1

A-7033 Pötttsching (Burgenland),

Phone: +43 2631 / 8005

FAX: +43 2631 / 8005 84

mail to: ffd@frank-dvorak.at

www.frank-dvorak.at