



Alternators

LSA 44.2 - 4 Pole

Electrical and mechanical data

SPECIALY ADAPTED FOR APPLICATIONS

The LSA 44.2 alternator is designed to be suitable for typical generator applications, such as: backup, standard production, cogeneration, marine applications, rental, telecommunications, etc.

COMPLIANT WITH INTERNATIONAL STANDARDS

The LSA 44.2 alternator conforms to the main international standards and regulations:

IEC 60034, NEMA MG 1.22, ISO 8528, CSA, CSA/UL, marine regulations, etc.

It can be integrated into a CE marked generator.

The LSA 44.2 is designed, manufactured and marketed in an ISO 9001 environment.

TOP OF THE RANGE ELECTRICAL PERFORMANCE

- Class H insulation.
- Standard 12-wire re-connectable winding, 2/3 pitch, type no. 6 .
- Voltage range: 220 V - 240 V and 380 V - 415 V (440 V) - 50 Hz / 208 V - 240 V and 380 V - 480 V - 60 Hz.
- High efficiency and motor starting capacity.
- Other voltages are possible with optional adapted windings:
 - 50 Hz: 440 V (no. 7), 500 V (no. 9), 600 V (no. 22 or 23), 690 V (no. 10 or 52)
 - 60 Hz: 380 V and 416 V (no. 8), 600 V (no. 9).
- Total harmonic content < 2%.
- R 791 interference suppression conforming to standard EN 55011 group 1 class B standard for European zone (CE marking).

EXCITATION AND REGULATION SYSTEM SUITED TO THE APPLICATION

Voltage regulator	Excitation system			Regulation options				
	SHUNT	AREP	PMG	Current transformer for paralleling	Mains paralleling R 726	3-phase sensing R 731 R 734 <small>mains paralleling unbalanced</small>		Remote voltage potentiometer
R 230	Std	-	-	-	-	-	-	√
R 438	-	Std	Std	√	√	√	√	√
R 448	optional	-	-	√	√	√	√	√

Voltage regulator accuracy +/- 0.5%.

PROTECTION SYSTEM SUITED TO THE ENVIRONMENT

- The LSA 44. 2 is IP 23.
- Standard winding protection for clean environments with relative humidity ≤ 95 %, including indoor marine environments.
- Options:
 - Filters on air inlet and air outlet (IP 44).
 - Winding protections for harsh environments and relative humidity greater than 95%.
 - Space heaters.
 - Thermal protection for winding.

REINFORCED MECHANICAL STRUCTURE USING FINITE ELEMENT MODELLING

- Compact and rigid assembly to better withstand generator vibrations.
- Steel frame.
- Cast iron flanges and shields.
- Twin-bearing and single-bearing versions designed to be suitable for engines on the market.
- Half-key balancing.
- Greased for life bearings (regreasable bearings optional)

ACCESSIBLE TERMINAL BOX PROPORTIONED FOR OPTIONAL EQUIPMENT

- Easy access to the voltage regulator and to the connections.
- Possible clusion of accessories for paralleling, protection and measurement.
- 8 way terminal block for reconnecting voltage reconnection.

Common data

Insulation class	H	Excitation system	SHUNT	A R E P or PMG
Winding pitch	2/3 (N° 6)	A.V.R. model	R 230	R 438
Terminals	12	Voltage regulation (*)	± 0,5 %	± 0,5 %
Drip proof	IP 23	Sustained short-circuit current	-	300% (3 IN) : 10s
Altitude	≤ 1000 m	Total harmonic TGH / THC (**)	at no load < 2 % - on load < 2%	
Overspeed	2250 min ⁻¹	Waveform : NEMA = TIF (**)	< 50	
Air flow	0,37 m ³ /s (50Hz)/ 0,44 (60Hz)	Wave form : I.E.C. = THF (**)	< 2 %	

(*) Steady state duty. (**) Total harmonic content line to line, at no load or full rated linear and balanced load.

Ratings 50 Hz - 1500 R.P.M.

kVA / kW - Power factor = 0,8																					
Duty T° C		Continuous duty 40° C					Continuous duty 40° C					Stand-by / 40° C			Stand-by / 27° C						
Class / T° K	H / 125° K					F / 105° K					H / 150° K			H / 163° K							
Phase	3 ph.			1 ph.		3 ph.			1 ph.		3 ph.			1 ph.		3 ph.			1 ph.		
Y	380V	400V	415V	440V	ΔΔ	380V	400V	415V	440V	ΔΔ	380V	400V	415V	440V	ΔΔ	380V	400V	415V	440V	ΔΔ	
Δ	220V	230V	240V	230V		220V	230V	240V	230V		220V	230V	240V	230V		220V	230V	240V	230V		
YY	220V					220V					220V				220V						
44.2 VS3	kVA	90	90	90	90	55	80	80	80	80	50	95	95	95	95	58	100	100	100	100	60
	kW	72	72	72	72	44	64	64	64	64	40	76	76	76	76	46	80	80	80	80	58
44.2 VS45	kVA	105	105	105	105	66	95	95	95	95	62	110	110	110	110	69	116	116	116	116	72
	kW	84	84	84	84	53	76	76	76	76	50	88	88	88	88	55	93	93	93	93	58
44.2 S7	kVA	120	125	120	120	73	110	112	110	110	65	126	131	126	126	77	132	138	132	132	82
	kW	96	100	96	96	58	88	90	88	88	52	101	105	101	101	62	106	110	106	106	66
44.2 S75	kVA	130	135	130	125	83	115	122	115	114	75	138	143	138	132	88	144	150	144	137	93
	kW	104	108	104	100	66	92	98	92	91	60	110	114	110	106	70	115	120	115	110	74
44.2 M95	kVA	150	150	145	125	94	135	135	130	114	87	156	156	150	132	101	165	165	160	137	104
	kW	120	120	116	100	75	108	108	104	91	70	125	125	120	106	81	132	132	128	110	83
44.2 L12	kVA	165	165	165	135	102	150	150	150	123	94	170	170	170	143	109	175	175	175	148	113
	kW	132	132	132	110	82	120	120	120	98	75	136	136	136	114	87	140	140	140	89	90

Ratings 60 Hz - 1800 R.P.M.

kVA / kW - Power factor = 0,8																					
Duty T° C		Continuous duty 40° C					Continuous duty 40° C					Stand-by / 40° C			Stand-by / 27° C						
Class / T° K	H / 125° K					F / 105° K					H / 150° K			H / 163° K							
Phase	3 ph.			1 ph.		3 ph.			1 ph.		3 ph.			1 ph.		3 ph.			1 ph.		
Y	380V	416V	440V	480V	ΔΔ	380V	416V	440V	480V	ΔΔ	380V	416V	440V	480V	ΔΔ	380V	416V	440V	480V	ΔΔ	
Δ	220V	240V	240V			220V	240V	240V			220V	240V	240V			220V	240V	240V			
YY	208V				240V	208V				240V	208V			240V	208V				240V		
44.2 VS3	kVA	95	100	105	115	65	85	90	95	105	59	100	105	110	120	69	105	110	115	125	72
	kW	76	80	84	92	52	68	72	76	84	47	80	84	88	96	55	84	88	92	100	58
44.2 VS45	kVA	109	117	123	131	74	101	108	113	122	68	117	125	131	138	79	120	129	135	144	81
	kW	87	94	98	105	59	81	86	90	98	54	94	100	105	110	63	96	103	108	115	65
44.2 S7	kVA	126	137	144	155	83	115	123	130	140	77	133	143	151	163	89	139	151	158	170	92
	kW	99	106	111	120	66	92	98	104	112	62	106	114	120	130	71	110	118	123	132	74
44.2 S75	kVA	136	146	155	169	95	122	132	139	152	85	143	154	163	178	100	150	162	172	187	105
	kW	109	117	124	135	76	98	106	111	122	68	114	123	130	142	80	120	130	138	150	84
44.2 M95	kVA	156	167	174	188	104	144	154	160	167	96	167	179	186	196	110	173	185	194	206	115
	kW	125	134	139	150	83	115	123	128	134	77	134	143	149	157	88	138	148	155	165	92
44.2 L12	kVA	169	180	190	206	110	155	165	171	185	102	181	193	200	215	118	187	201	209	225	123
	kW	135	144	152	165	88	124	132	137	148	82	145	154	160	172	94	150	161	167	180	98

Efficiencies 50 Hz - P.F. : 1 / P.F. : 0,8

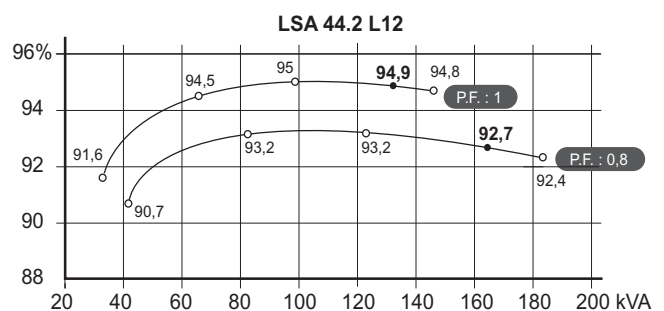
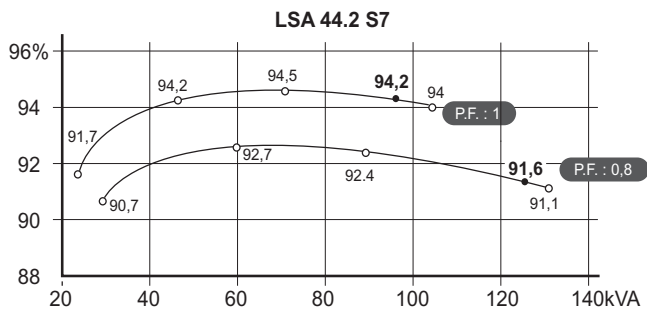
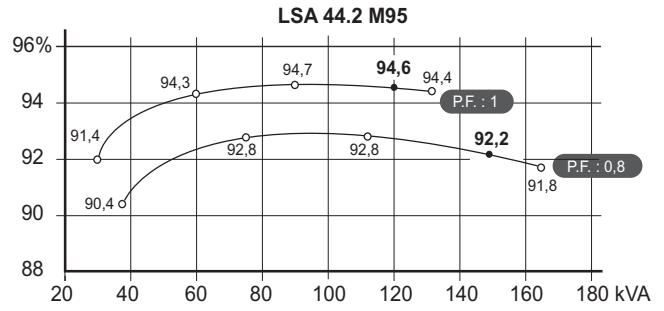
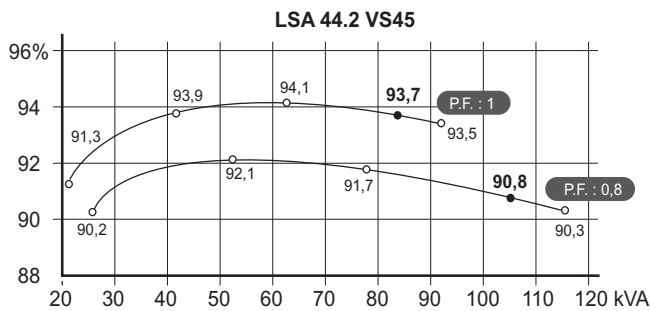
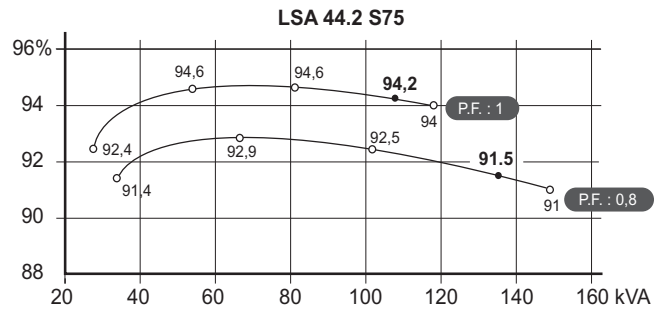
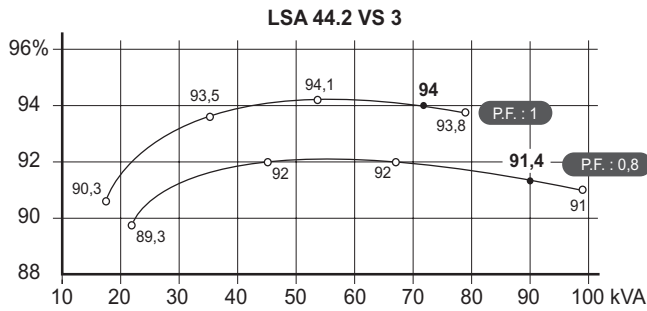

Reactances (%) . Time constants (ms) - Class H / 400 V

	VS3	VS45	S7	S75	M95	L12
Kcc Short-circuit ratio	0,40	0,35	0,33	0,31	0,42	0,43
Xd Direct axis synchro.reactance unsaturated	311	362	363	392	317	306
Xq Quadra. axis synchr.reactance unsaturated	186	217	218	235	190	184
T'do Open circuit time constant	2555	2555	2734	2734	2865	2966
X'd Direct axis transient reactance saturated	12,1	14,1	13,2	14,3	11	10,3
T'd Short-Circuit transient time constant	100	100	100	100	100	100
X''d Direct axis subtransient reactance saturated	7,3	8,5	7,9	8,6	6,6	6,2
T''d Subtransient time constant	10	10	10	10	10	10
X''q Quadra. axis subtransient reactance saturated	8,9	10,4	9,6	10,3	7,8	7,2
Xo Zero sequence reactance unsaturated	0,3	0,5	0,7	0,9	0,1	0,8
X2 Negative sequence reactance saturated	8,1	9,5	8,8	9,5	7,3	6,7
Ta Armature time constant	15	15	15	15	15	15

Other data - Class H / 400 V

io (A) No load excitation current (SHUNT / AREP or PMG)	0,5/1	0,5/1	0,5/1	0,5/1	0,6/1,2	0,5/1
ic (A) Full load excitation current (SHUNT / AREP or PMG)	1,8/3,6	2,1/4,2	2/3,8	2,1/4,2	2/4	1,9/3,8
uc (V) Full load excitation voltage (SHUNT / AREP or PMG)	33/17	38/19	36/17	38/19	36/18	34/17
ms Recovery time ($\Delta U = 20\%$ trans.)	500	500	500	500	500	500
kVA Motor start. ($\Delta U = 20\%$ sust.) or ($\Delta U = 50\%$ trans.) SHUNT	194,4	194,4	243,9	246,4	284,2	331,4
kVA Motor start. ($\Delta U = 20\%$ sust.) or ($\Delta U = 50\%$ trans.) AREP	227,9	227,9	286,2	287,3	329,2	383,1
% Transient dip (rated step load) SHUNT / PF : 0,8 LAG	15,6	17,3	16,6	17,5	14,7	14
% Transient dip (rated step load) AREP / PF : 0,8 LAG	13	14,3	13,4	14,4	12,2	11,7
W No load losses	1800	1800	1970	1970	2620	2830
W Heat rejection	6760	8500	9410	9980	10150	10330

Transient voltage variation 400 V - 50 Hz

Load application (Shunt excitation)

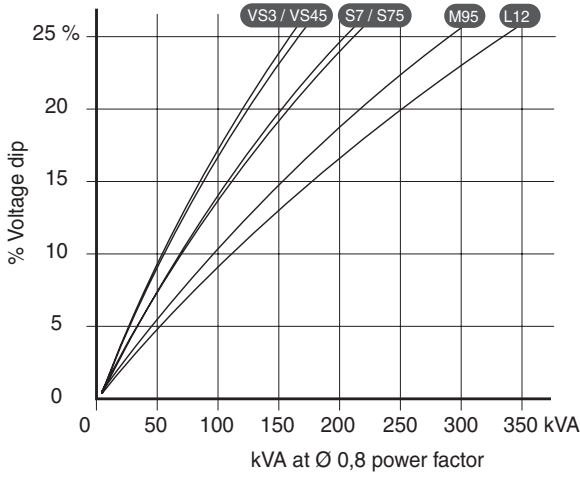

Load application (AREP ou PMG excitation)

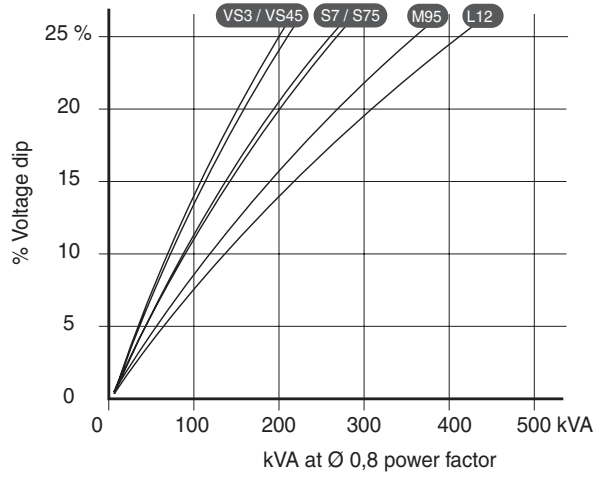

Load rejection (Shunt excitation)

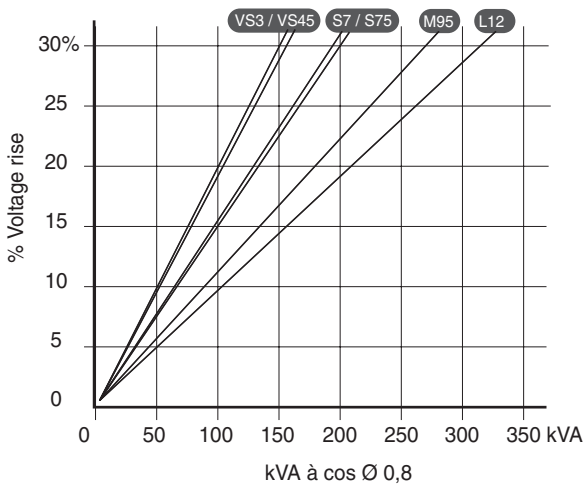

Load rejection (AREP or PMG excitation)

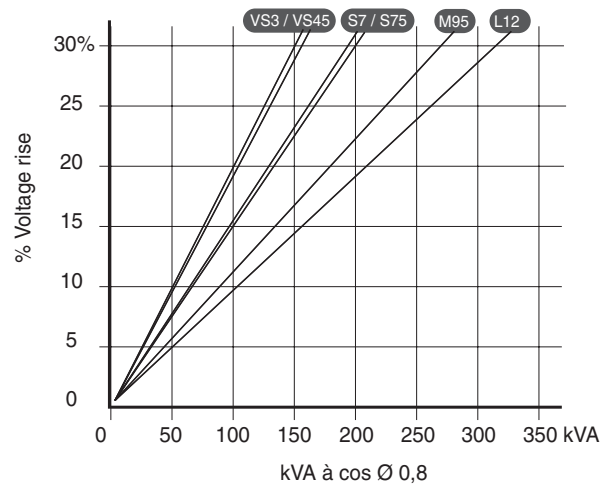

Motor starting (SHUNT excitation)

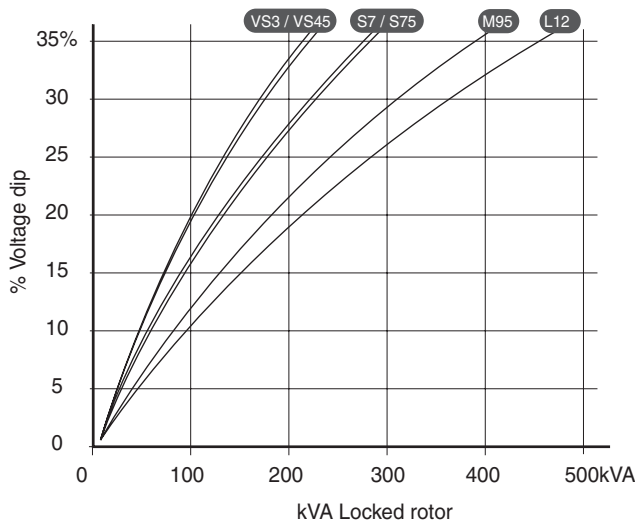

Motor starting (AREP or PMG excitation)

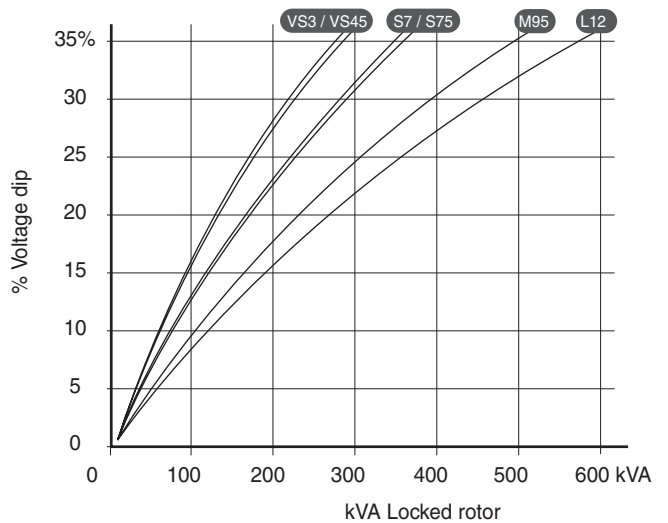

- 1) For a starting P.F. differing from 0,6 , the starting kVA must be multiplied by $(\text{Sine } \varnothing / 0,8)$
- 2) For voltages other than 400V(Y) , 230V() at 50 Hz, then kVA must be multiplied by $(400/U)^2$ or $(230/U)^2$.

Efficiencies 60 Hz - P.F. : 1 / P.F. : 0,8

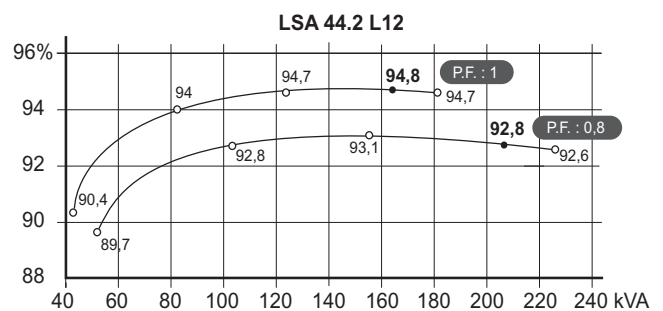
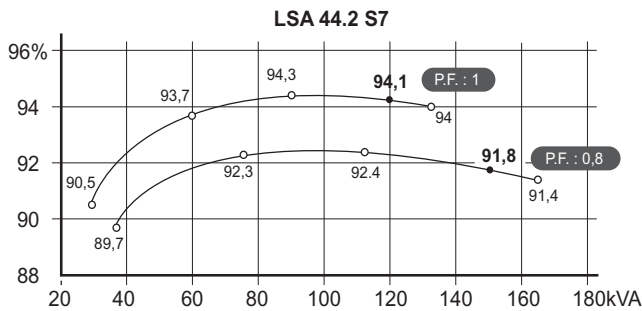
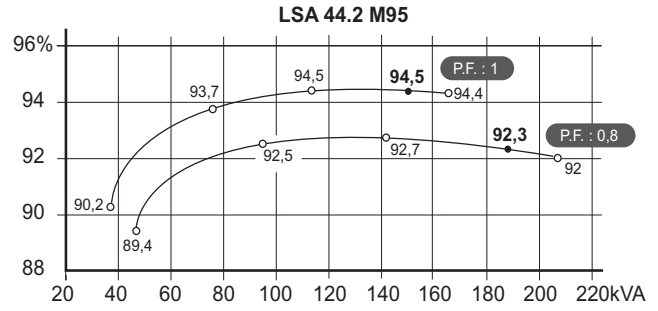
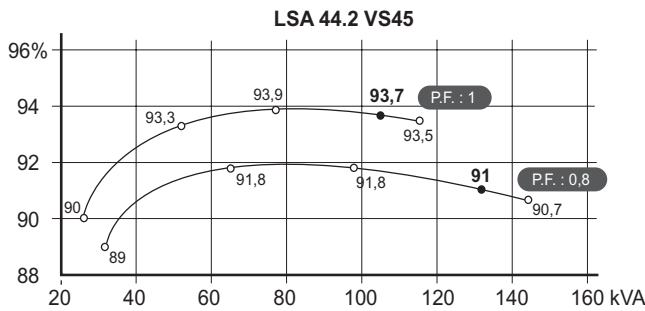
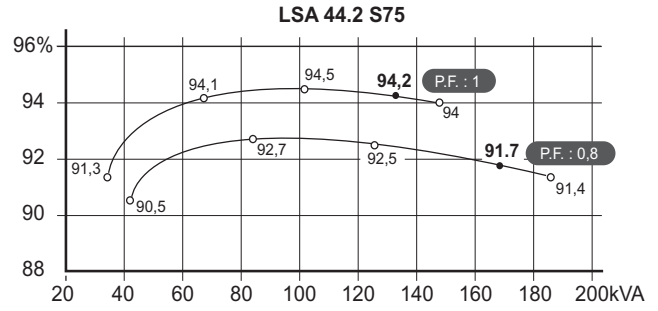
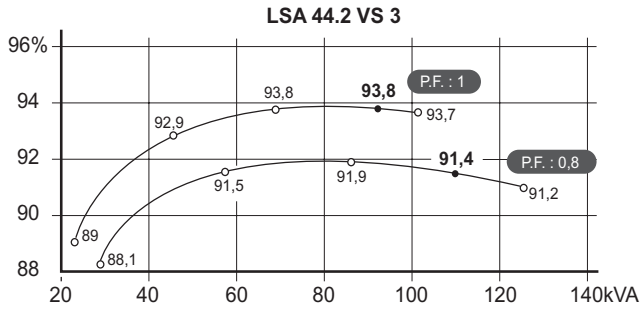

Reactances (%) . Time constants (ms) - Class H / 480 V

	VS3	VS45	S7	S75	M95	L12
Kcc Short-circuit ratio	0,38	0,33	0,33	0,29	0,41	0,41
Xd Direct axis synchro.reactance unsaturated	331	377	363	409	331	319
Xq Quadra. axis synchr.reactance unsaturated	198	226	218	245	198	191
T'do Open circuit time constant	2555	2555	2734	2734	2865	2966
X'd Direct axis transient reactance saturated	12,9	14,7	13,2	14,9	11,5	10,7
T'd Short circuit transient time constant	100	100	100	100	100	100
X''d Direct axis subtransient reactance saturated	7,7	8,8	7,9	8,9	6,9	6,4
T''d Subtransient time constant	10	10	10	10	10	10
X''q Quadra. axis subtransient reactance saturated	9,5	10,8	9,6	10,8	8,2	7,5
Xo Zero sequence reactance unsaturated	0,6	0,9	0,7	0,5	0,2	0,5
X2 Negative sequence reactance saturated	8,7	9,9	8,8	9,9	7,6	7
Ta Armature time constant	15	15	15	15	15	15

Other data - Class H / 480 V

io (A) No load excitation current (SHUNT / AREP or PMG)	0,5/1	0,5/1	0,5/1	0,5/1	0,6/1,2	0,5/1
ic (A) Full load excitation current (SHUNT / AREP or PMG)	1,8/3,6	2,1/4,2	1,9/3,8	2,1/4,2	2/4	1,9/3,8
uc (V) Full load excitation voltage (SHUNT / AREP or PMG)	34/17	38/19	36/18	40/20	38/19	36/18
ms Recovery time ($\Delta U = 20\%$ trans.)	500	500	500	500	500	500
kVA Motor start. ($\Delta U = 20\%$ sust.) or ($\Delta U = 50\%$ trans.) SHUNT	238,2	238,2	300,7	301,6	349,9	408,8
kVA Motor start. ($\Delta U = 20\%$ sust.) or ($\Delta U = 50\%$ trans.) AREP	280,4	280,4	351,8	352,8	407,1	478,2
% Transient dip (rated step load) SHUNT / PF : 0,8 LAG	16,3	17,8	16,6	18	15,1	14,4
% Transient dip (rated step load) AREP / PF : 0,8 LAG	13,5	14,7	13,7	14,8	12,5	12
W No load losses	2720	2720	2960	2960	3870	4170
W Heat rejection	8550	10250	10680	12070	12440	12680

Transient voltage variation - 480 V - 60 Hz

Load application (SHUNT excitation)

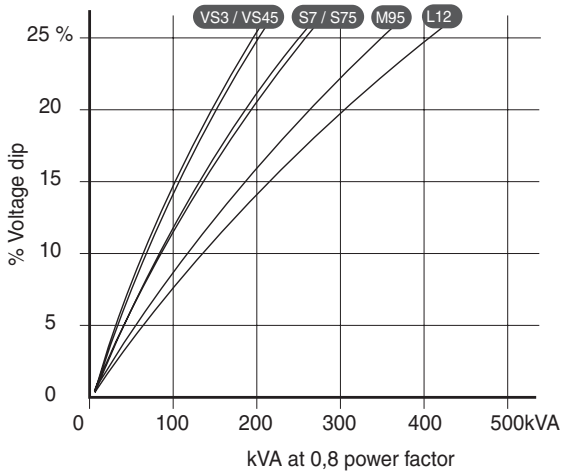

Load application (AREP or PMG excitation)

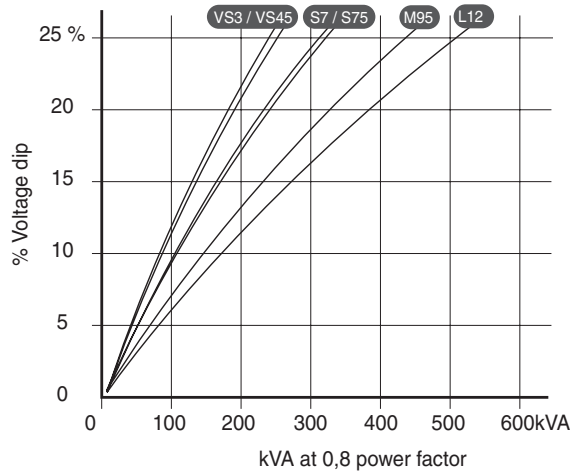

Load rejection (SHUNT excitation)

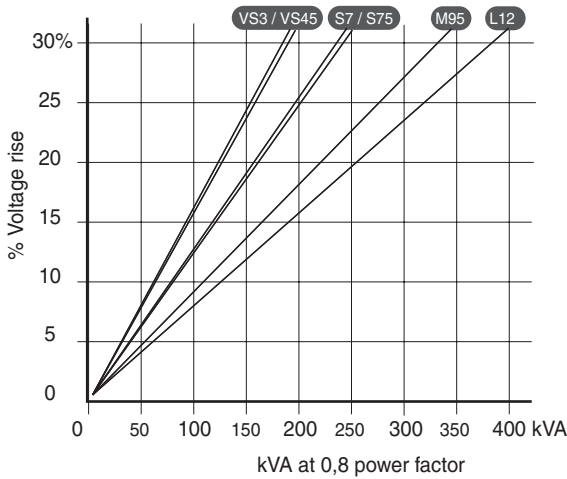

Load rejection (AREP or PMG excitation)

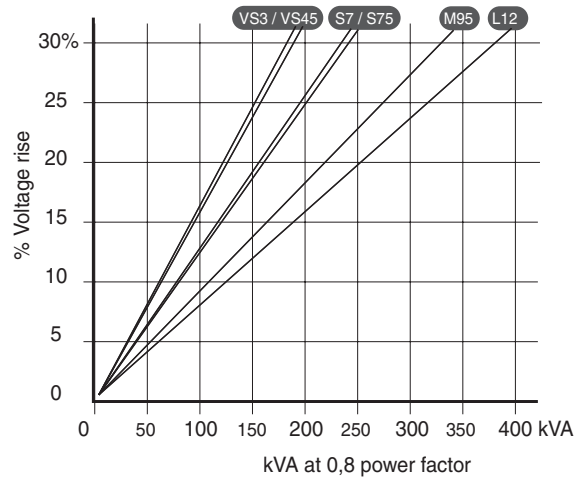

Motor starting (SHUNT excitation)

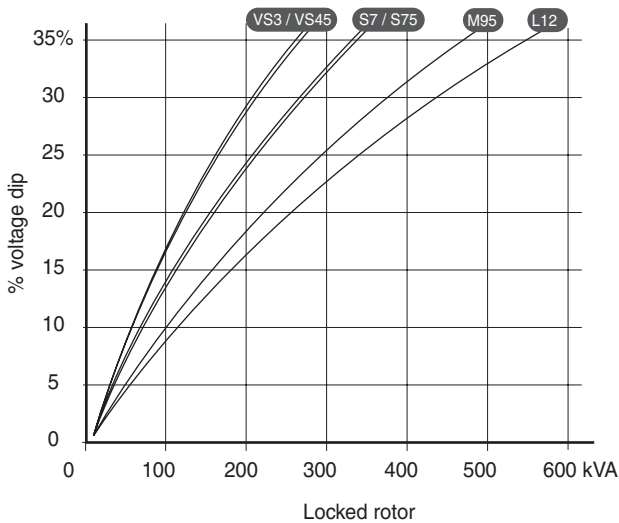

Motor starting (AREP or PMG excitation)

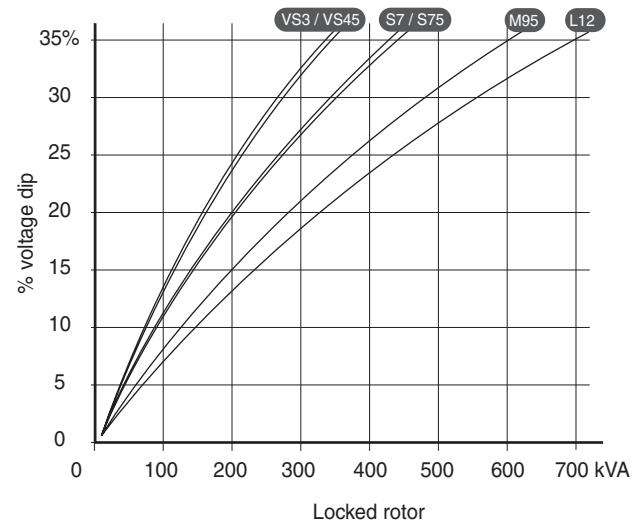

1) For a starting P.F. differing from 0,6 , the starting kVA must be multiplied by $(\text{Sine } \varnothing / 0,8)$

2) For voltages other than 480V(Y), 277V(), 240V(YY) at 60 Hz, then kVA must be multiplied by $(480/U)^2$ or $(277/U)^2$ or $(240/U)^2$.

3 phase short-circuit curves at no load and rated speed (star connection Y)

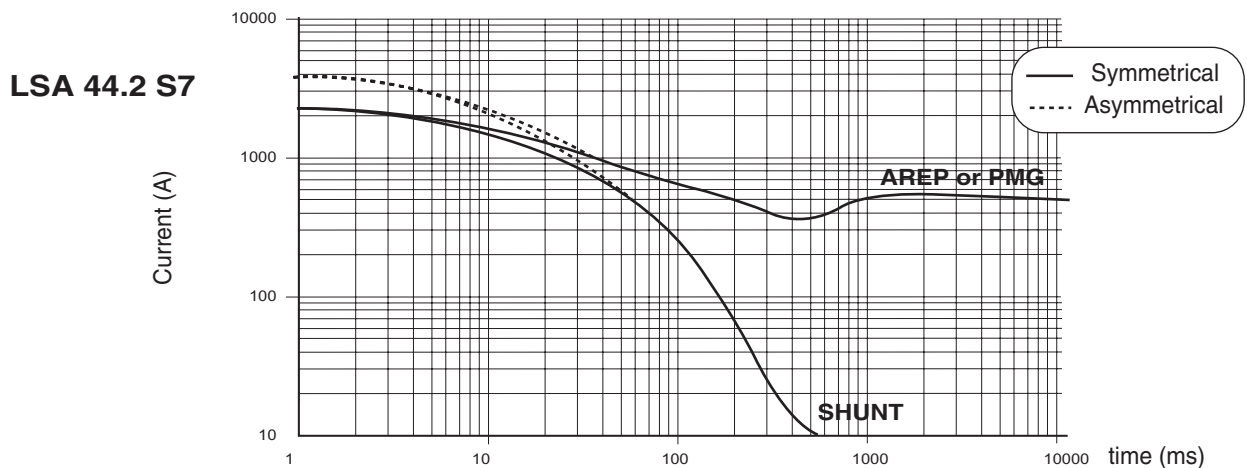
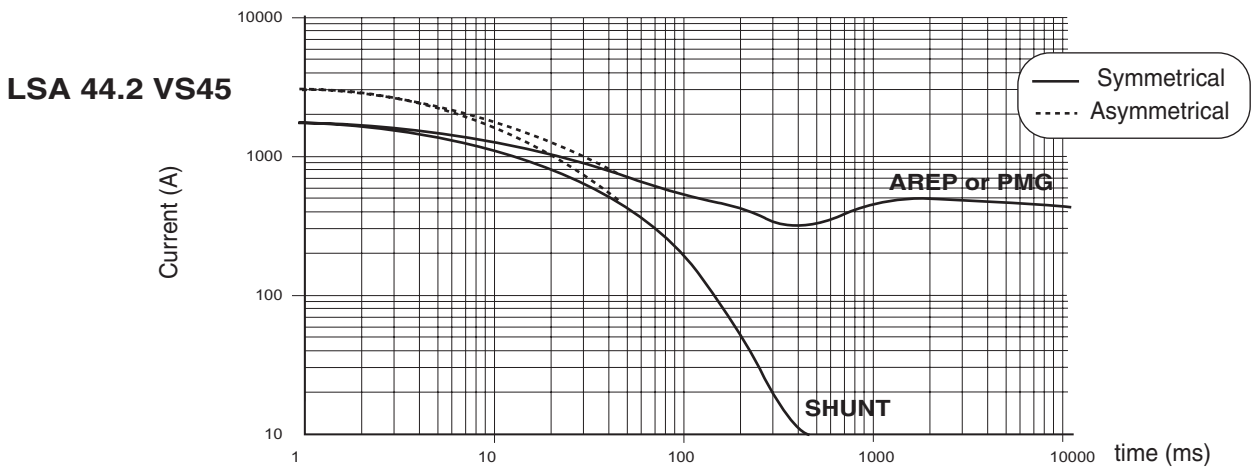
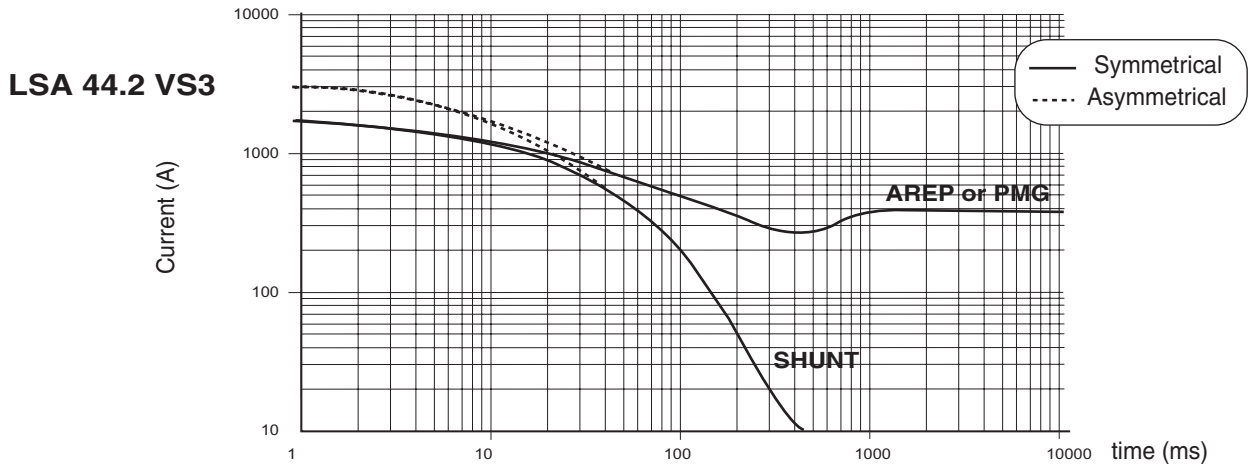

Influence due to connexion.

Curves shown are for star connection (Y).

For other connections, use the following multiplication factors :

- Series delta : Current value x 1,732
- Parallel star : Current value x 2

3 phase short-circuit curves at no load and rated speed (star connection Y)

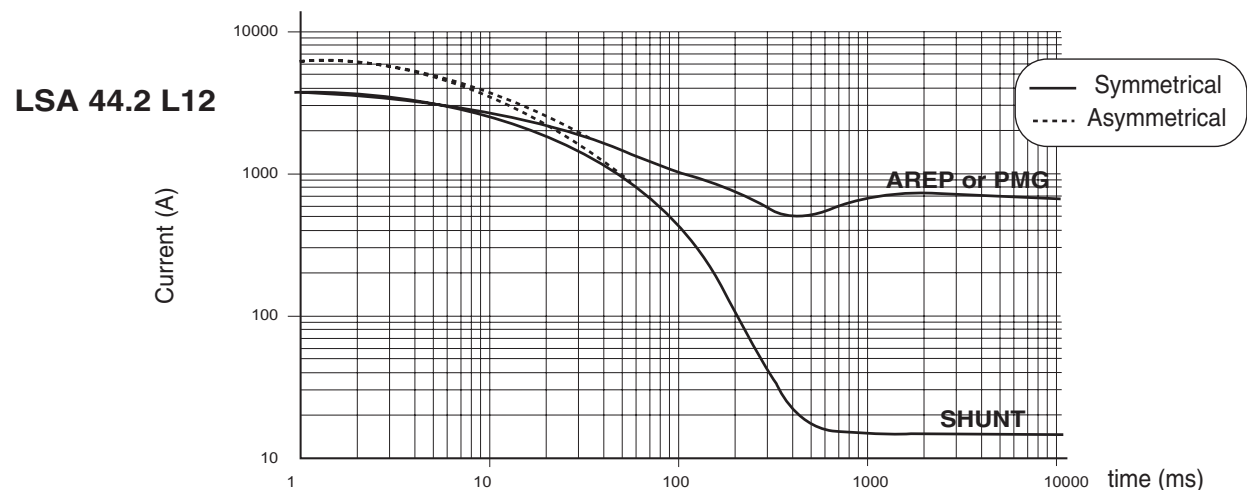
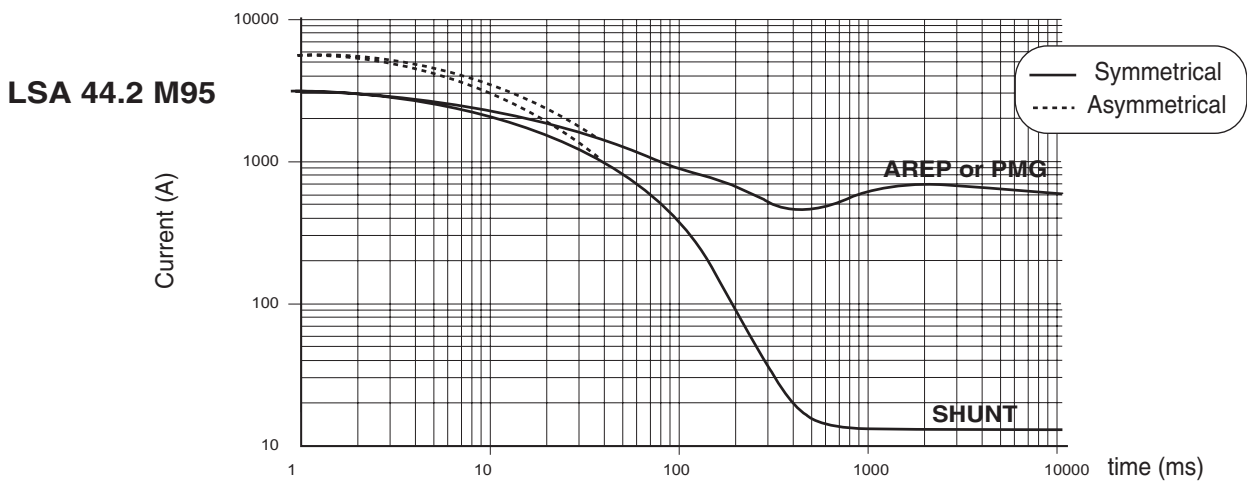
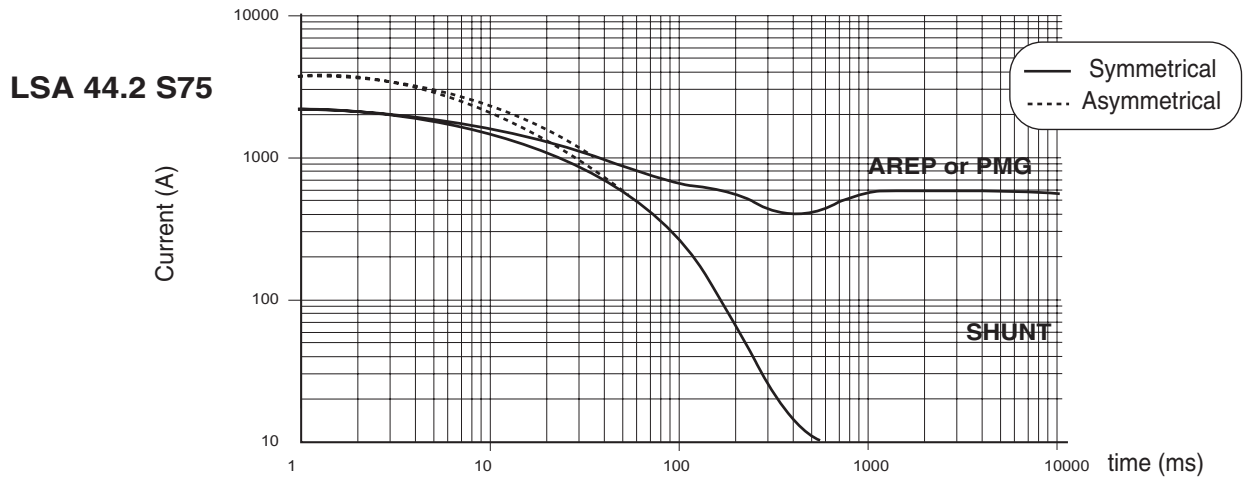

Influence due to short-circuit.

Curves are based on a three-phase short-circuit.

For other types of short-circuit, use the following multiplication factors:

	3 phase	2 phase L - L.	1 phase L - N.
Instantaneous (Max)	1	0,87	1,3
Sustained	1	1,5	2,2
Max sustained duration (AREP/ PMG)	10 sec.	5 sec.	2 sec.

Single bearing dimensions

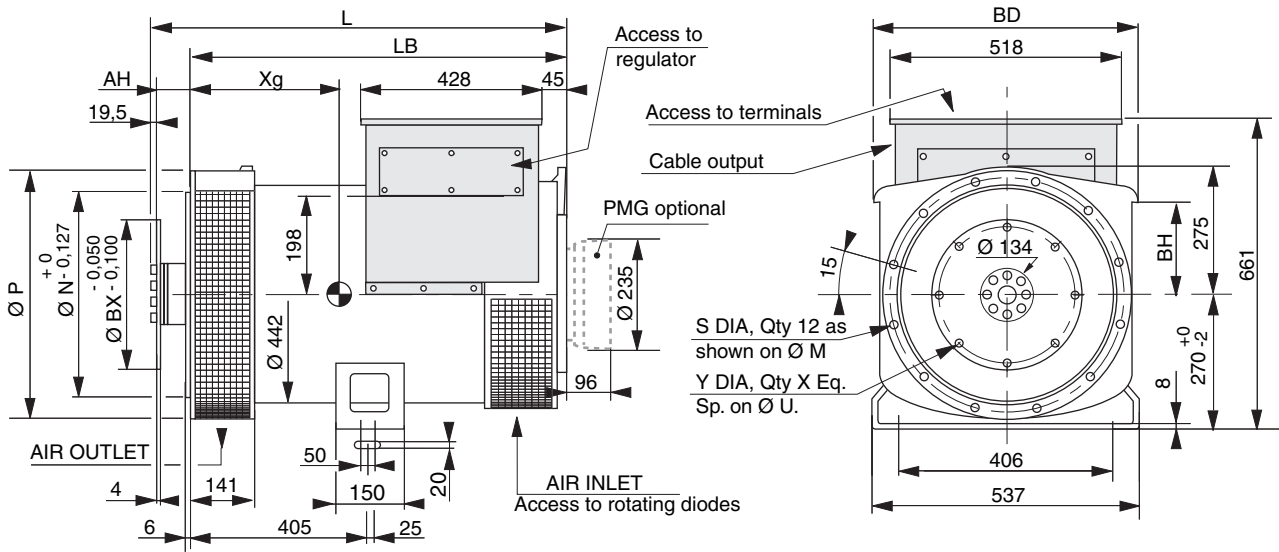

Frame dimensions				
TYPE	L max without	LB	Xg	Weight (kg)
LSA 44.2 VS3	755	685	335	385
LSA 44.2 VS45	755	685	335	385
LSA 44.2 S7	815	745	365	440
LSA 44.2 S75	815	745	365	440
LSA 44.2 M95	875	805	395	495
LSA 44.2 L12	935	865	420	550

Coupling			
Flex plate	10	11 ^{1/2}	14
Flange S.A.E 3	X	X	
Flange S.A.E 2	X	X	
Flange S.A.E 1		X	X

Flange (mm)						
S.A.E.	BD	S	BH	P	N	M
3	530	11	210	450	409,575	428,625
2	530	11	210	488	447,675	466,725
1	590	12,5	240	554	511,175	530,225

Flex plate (mm)					
S.A.E.	BX	U	X	Y	AH
14	466,72	438,15	8	14	25,4
11 1/2	352,42	333,38	8	11	39,6
10	314,32	295,28	8	11	53,8

Torsional analysis data

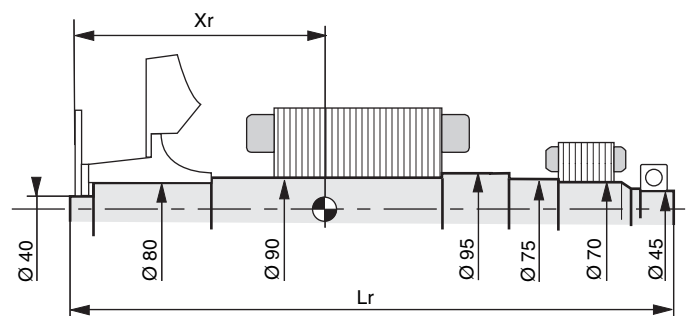

TYPE	Flex plate S.A.E. 10				Flex plate S.A.E. 11 1/2				Flex plate S.A.E. 14			
	Xr	Lr	M	J	Xr	Lr	M	J	Xr	Lr	M	J
LSA 44.2 VS3	366	731	140,4	0,8569	352	731	140	0,8689	337	731	140,7	0,9329
LSA 44.2 VS45	366	731	140,4	0,8569	352	731	140	0,8689	337	731	140,7	0,9329
LSA 44.2 S7	395	791	162,9	1,0078	382	791	163	1,0198	367	791	163,2	1,0838
LSA 44.2 S75	395	791	162,9	1,0078	382	791	163	1,0198	367	791	163,2	1,0838
LSA 44.2 M95	425	851	185,4	1,1587	412	851	185	1,1707	397	851	185,8	1,2347
LSA 44.2 L12	456	911	207,9	1,3095	443	911	208	1,3215	427	911	208,3	1,3855

Two bearing dimensions

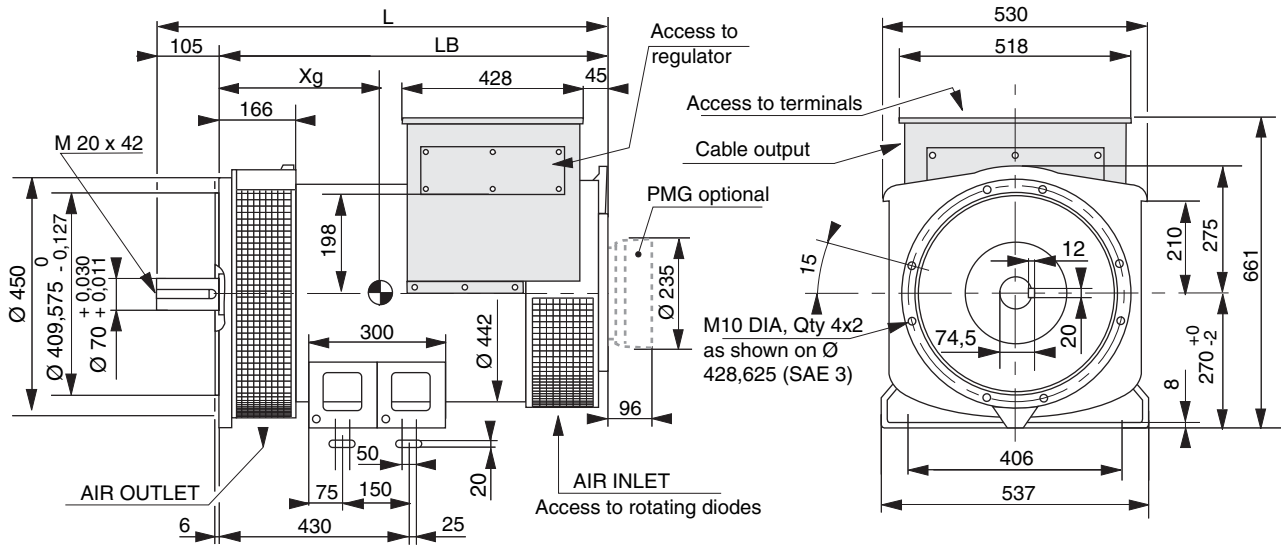

Frame dimensions

TYPE	L max without PMG	LB	Xg	Weight (kg)
LSA 44.2 VS3	815	710	360	405
LSA 44.2 VS45	815	710	360	405
LSA 44.2 S7	875	770	390	460
LSA 44.2 S75	875	770	390	460
LSA 44.2 M95	935	830	420	515
LSA 44.2 L12	995	890	450	570

Torsional analysis data

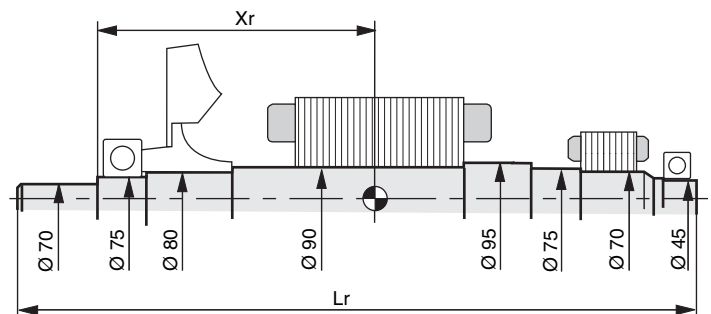

Gravity center : Xr (mm), Rotor length Lr (mm), Weight : M (kg), Moment of inertia : J (kgm²) : (4J = MD²)

TYPE	Xr	Lr	M	J
LSA 44.2 VS3	341	803	137	0,8276
LSA 44.2 VS45	341	803	137	0,8276
LSA 44.2 S7	371	863	160	0,9785
LSA 44.2 S75	371	863	160	0,9765
LSA 44.2 M95	422	923	182	1,1294
LSA 44.2 L12	473	983	205	1,2803



MOTEURS LEROY-SOMER 16015 ANGOULÊME CEDEX - FRANCE

338 567 258 RCS ANGOULÊME
S.A. au capital de 62 779 000 €

www.leroy-somer.com